

FDS 355

User Manual

Software version 1.10 and above



This equipment has been tested and found to comply with the following European and international Standards for Electromagnetic Compatibility and Electrical Safety:

Radiated Emissions (EU):	EN55013	(1990)	Associated Equipment
RF Immunity (EU):	EN50082/1	(1992)	RF Immunity, Fast Transients ESD
Mains Disturbance (EU):	EN61000/3/2	(1995)	
Electrical Safety (EU):	EN60065	(1993)	
Radiated Emissions (USA):	FCC part 15 Class B		
Electrical Safety (USA):	UL813/ETL	(1996)	Commercial Audio Equipment
Electrical Safety (CAN):	UL813/ETLc	(1996)	Commercial Audio Equipment

IMPORTANT SAFETY INFORMATION

DO NOT REMOVE COVERS. NO USER SERVICABLE PARTS INSIDE, REFER SERVICING TO QUALIFIED SERVICE PERSONNEL. THIS EQUIPMENT MUST BE EARTHED.



CAUTION
RISK OF ELECTRIC SHOCK
DO NOT OPEN
DO NOT EXPOSE
TO RAIN OR MOISTURE



ATTENTION
RISQUE DE CHOC ELECTRIQUE
NE PAS ENLEVER
NE PAS EXPOSER A
LA PLUIE NI A L'HUMIDITE

IT SHOULD NOT BE NECESSARY TO REMOVE ANY PROTECTIVE EARTH OR SIGNAL CABLE SHIELD CONNECTIONS TO PREVENT GROUND LOOPS. ANY SUCH DISCONNECTIONS ARE OUTSIDE THE RECOMMENDED PRACTISE OF BSS AUDIO AND WILL RENDER ANY EMC OR SAFETY CERTIFICATION VOID.

For continued compliance with international EMC legislation ensure that all input and output cables are wired with the cable screen connected to Pin 1 of the XLR connectors. The input XLR Pin 1 is connected to the chassis via a low value capacitor, providing high immunity from ground loops whilst ensuring good EMC performance.

We have written this manual with the aim of helping installers and sound engineers to get to grips with the **FDS-355** and obtain its maximum capability. If you are new to BSS products, we recommend that you begin at the start of the manual.

We welcome any comments or questions regarding the **FDS-355** or other BSS products, and you may contact us at the address or World Wide Web site given in the warranty section.

Contents

	Quick Start - Reference	5
	FDS-355 Omnidrive	5
1.0	Introduction	8
1.1	OMNIDRIVE™ Compact Loudspeaker Management System	8
1.2	Other features	8
1.3	Voltage setting	9
1.4	AC Power fusing	9
2.0	Unpacking	9
3.0	Mechanical Installation	10
4.0	Mains Power Connection	11
4.1	Mains power	11
5.0	Controls	12
5.1	Input section	12
5.2	Output section	14
5.3	Rear panel	15
	Screen Layout	16
6.0	Default Screen	20
7.0	Utilities Menu	21
8.0	Inputs Menu	25
9.0	Outputs Menu	26
10.0	EQ Screens	30
11.0	Store and Recall	32
11.1	Storing	32
11.2	Recalling	33
12.0	System Headroom Management	34

Contents

13.0	Phase Compensation	34
14.0	Typical Applications	35
14.1	Stereo 2-Way with a mono sub-bass	35
14.2	Dual Bi-amp (Stage monitors)	35
14.3	5-Way zoning distribution	35
14.4	Mono 5-way	36
15.0	Quick Reference - How to ...	37
15.1	Use delays to Time align ^(R) drivers	37
15.2	Keep relative delays while delaying a group	37
15.3	Name a band	37
15.4	Make a band full range	37
15.5	Add EQ for Constant Directivity horns	38
15.6	Loading custom logos	38
16.0	PC Card	39
16.1	Card types	39
16.2	PC Card format	39
17.0	System Security	40
17.1	Program lock	40
17.2	Lock mode	40
17.3	OWNER lock	40
17.4	OEM lock	41
17.5	Safe	42
18.0	Troubleshooting	43
19.0	Warranty Information	44
20.0	Specifications	45
	Index	
	User Notes	
	Spare Parts Information	

Quick Start - Reference

FDS-355 AC Power connection
Omnidrive The FDS-355 has a universal voltage AC Power input. Connect the FDS-355 to AC Power with the lead supplied. The unit will switch on automatically (there is no separate on/off switch). The display will show the default screen, with the current program (if selected), and overall system response curves.

Audio connections

Connect the inputs and outputs as desired. All inputs and outputs are electronically balanced, with Pin 2 hot signal (+ve). Do not put any audio through the unit at this time.

Program settings

If your FDS-355 has been already configured with a program, you only need to use the RECALL mode to set the parameters to that program.

Press RECALL. Turn the parameter wheel to select the designated program (which has a number and name) and press RECALL again. Programs marked with diamonds are 'OEM' programs and have been designed to match specific sound systems.

Some units will be locked (*refer to section 17.0; System Security*) to a specific program. In this case most controls will be disabled and the unit will be ready for use.

Recalling a program from a PC Card

To load a file from a PC card, push the card into the slot on the front panel of the FDS-355. Press RECALL. Push the DOWN key to highlight 'Int', and turn the encoder to select *CPrg* (or *CALL* for a full PC Card recall). Push the UP key to return to file selection, and turn the parameter wheel to select the file. Push RECALL again to recall the file.

Setting up a system

To configure your FDS-355, the mode of the unit should be decided upon before setting up.

Once the Config is set (In the Utilities menu), the crossover points, individual band delays, any EQ, and limiter thresholds can be set up.

To enter the Utilities menu, press the UP key from the default screen.

Configuring the FDS-355

The FDS-355 has 2 modes from which the unit can be configured: Stereo 2-Way with sub (Stereo), or Mono 5-way (MONO). To select the mode you wish to use, enter the Utilities menu, and press the UP key until you reach the Config screen. Turn the parameter wheel to select the option you wish to use.

NOTE: When the configuration is changed, the unit will prompt for confirmation of the action. If the STORE key is pressed, then the mode will change, and DEFAULT VALUES WILL BE RESTORED. It is advisable to do a 'Store' before changing modes if you have set up a program.

Quick Reference

Setting the crossover points

Select the band to be edited by pushing the parameter wheel to cycle through inputs and outputs. Note the LEDs above each channel change as the screen changes.

Once the band has been selected, press the UP/DOWN keys until the first crossover (Filter shape - Low slope) screen appears. Select the type of filter shape by using the parameter wheel to cycle through the selection. **Refer to section 9.0; Outputs Menu** for more info on crossover filter shapes. Pushing the UP key from here will move to the Filter Frequency (Low slope) screen. Use the parameter wheel to select the frequency. The high slope screen are then access after this screen by pushing the UP key (once or twice).

Band delays

Use the UP/DOWN keys until the delay screen appears. The delay is adjusted using the parameter wheel. Default settings for display and adjustment of delay is in meters (m), but can be changed to milliseconds (ms), or feet/inches (ft).

Bands can also be linked so multiple outputs can be delayed as one using the delay link facility.

Adding EQ

Use the UP/DOWN keys to move to the EQ screen. The EQ shape can be edited first. The shape of the EQ can be selected from one of the following by turning the parameter wheel:

Hi-Shelf with 12dB slope (Hi12)

Hi-Shelf with 6dB slope (Hi6)

BELL

Low-Shelf with 6dB slope (Lo6)

Low-Shelf with 12dB slope (Lo12).

Pushing the UP key from the EQ shape screen will access the following screens, in this order:

Filter Frequency screen

Cut/Boost screen

Filter Bandwidth screen

Setting the limiters

There are two screens associated with the limiters of the FDS-355, which allow you to:

Turn the limiters on/off

Adjust the limiter threshold..

In the limiter on/off screen, turning the parameter wheel will select whether the limiters are on or not. Pushing the UP key from this screen will access the limiter threshold screen, and turning the parameter wheel will change the threshold. The output meters are calibrated to this threshold, so the threshold will show as '0' on the meter at all times, even if the limiters are off. The thresholds are indicated in dBu, but can be changed to mV via the Limiter Units screen in the utilities menu.

Automatic Phase Compensation

Automatic phase compensation is employed in the FDS-355 to maintain zero phase difference between adjacent bands, even in 4 and 5-Way systems, where the phase errors due to the effects of closely spaced crossover filters can be significant. Phase compensation helps you to keep the response of the system with the minimum of 'fiddle factor' adjustments.

Headroom Management System (H.M.S)

Headroom Management System manipulates the gain structure to make maximum use of the dynamic range of critical components, resulting in lower noise levels with sensitive amplifiers, where limiter thresholds are low.

Introduction

1.0 Introduction

- 1.1 **OMNIDRIVE™ Compact Loudspeaker Management System** An arrangement of 3 inputs and 5 outputs, and an additional internal sum of inputs A&B, can be matrixed in any combination to provide a complete loudspeaker management system with integral crossovers, delays, EQ, and protection limiters.
- In stage monitor systems, the FDS-355 can function as a dual bi-amp crossover with delay, limiters and EQ, providing a solution to on-stage hotspots caused by monitors with identical signals, which can be eliminated by applying small delays between wedges.

Furthermore, the FDS-355 can function as a distribution unit to multizone systems where crossovers may be passive or local to the loudspeaker. In this case, the provision of delays and EQ can radically enhance such a system, while reducing both processing costs and required rack space.

The FDS-355 brings the power and usability of OMNIDRIVE into 1U of rack space. It has new 24-bit A-D input converters giving further improvement in dynamic range, together with the familiar OMNIDRIVE 20-bit D-A converters.

A new BSS technique has been used, which combines system software and hardware to optimise the performance of the output converters. This ensures that the D-A is always operating at full range, minimising converter noise whatever the system operating level.

All the system operating software is held in flash EPROM, which means that upgrading to new software is easy - either via PC card or from a PC via the MIDI or RS-232 ports. 60 internal program locations are available to the user for storing system setups, which may be generic system programs or complete venue settings. These memories may be stored onto a PC card for backup or archiving. The FDS-355 can also be configured as a fully secure unit, with password protection at multiple levels to prevent unauthorised tampering.

- 1.2 Other features
- Crossover slopes of 6,12, 18, 24 or 48dB per octave, filter types Butterworth, Bessel or Linkwitz-Riley, as appropriate.
 - Output limiters on each band (mid-filter).
 - High resolution input and output delays up to 1.3 seconds in 11 microsecond steps.
 - Input LED metering, showing signals from -20dB to clip level.
 - Output LED metering, showing signals from -20dB to +6dB over limit threshold.
 - Front panel output level trims and Mutes
 - Polarity reverse on each output.
 - Phase adjustment for each output.
 - PC card port for storage and recall of program settings
 - Electronically balanced inputs and outputs with transformer options.
 - MIDI and RS-232 ports on rear panel.

Voltage/Fusing Unpacking

1.3 Voltage setting The FDS-355 uses a switched-mode power supply which offers high efficiency and low heat generation. This power supply accepts universal AC Power input voltages in the range 100V AC to 240V AC (nominal), and requires no setting adjustment for AC power voltages in this range. Minimum AC input voltage is 90 Volts, and the maximum is 264 volts.

Outside these ranges the unit will not work satisfactorily, if at all. Voltages in excess of the maximum will probably cause damage. Voltages below the minimum will cause complete system shutdown. The flash memory in the unit will preserve all data in the event of a power failure.

1.4 AC Power fusing The Green-and-Yellow wire of the mains cord must always be connected to an installation Safety Earth or Ground. The Earth is essential for personal safety as well as the correct operation of the system, and is internally connected to all exposed metal surfaces. Any rack framework into which this unit may be mounted is assumed to be connected to the same grounding circuit.

The incoming mains power is fused within the FDS-355 by the fuse holder mounted on the rear panel. Always replace with an identical 20mm x 5mm 'T' fuse, rated at 1A for continued protection from equipment damage and fire. Spare fuses of the correct rating are supplied with the unit.

It is most important for continued safety that this specification is strictly adhered to.

Fig 1.1 Mains fuse on rear panel.



2.0 Unpacking

As part of BSS' system of quality control, this product is carefully inspected before packing to ensure flawless appearance.

After unpacking the unit, please inspect for any physical damage and retain the shipping carton and ALL relevant packing materials for use should the unit need returning.

In the event that damage has occurred, please notify your dealer **immediately**, so that a written claim to cover the damages can be initiated. **See Section 19.0.**

Mechanical Installation

3.0 Mechanical Installation

A vertical rack space of 1U (1¾" / 44.5 mm high) is required. Ventilation gaps are unnecessary (*See Figure 3.1*).

If the FDS-355 is likely to undergo extreme vibration through extensive road trucking and touring, it is advisable to support the unit at the rear and/or sides to lessen the stress on the front mounting flange. The necessary support can generally be bought ready-built as a rack tray. As with any low-level signal processing electronics, it is best to avoid mounting the unit next to a strong source of magnetic radiation, for example, a high power amplifier, to help keep residual noise levels in the system to a minimum.

Fig 3.1 Unit dimensions.

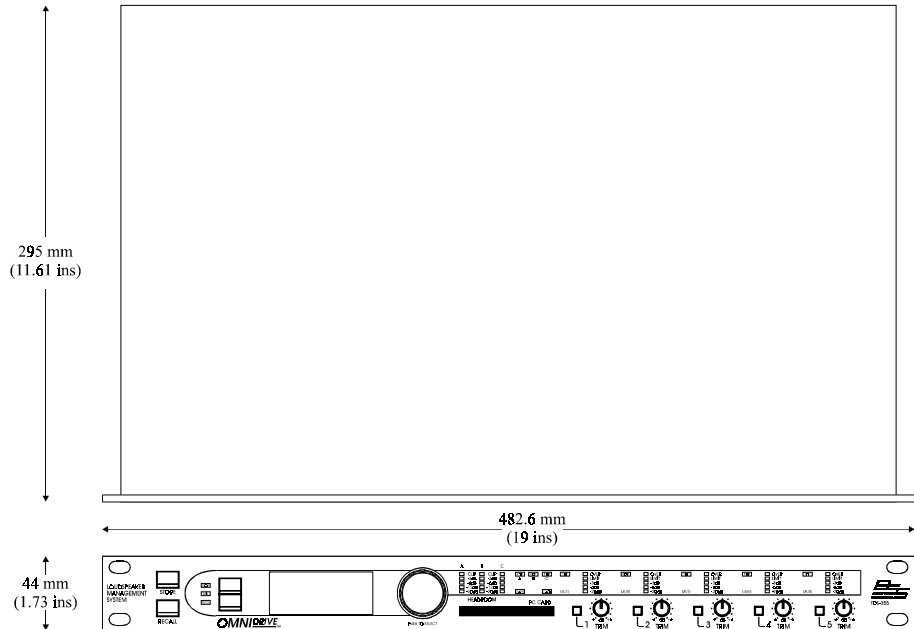
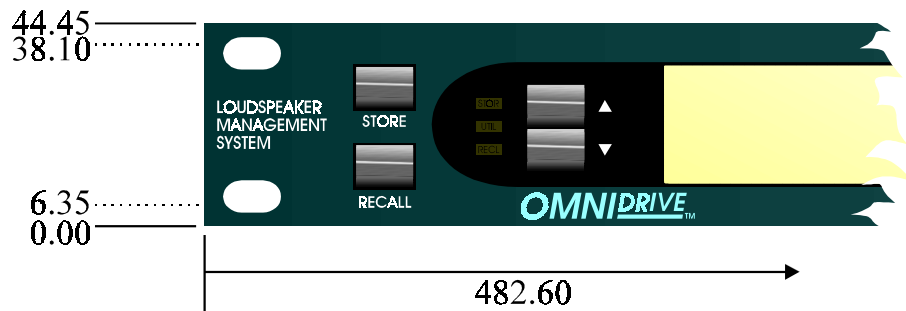

Fig 3.2 Rack dimensions.



Note: All dimensions in mm.

4.0 Mains Power Connection

4.1 Mains power *Refer also to sections 1.3 and 1.4; Voltage setting and AC Power Fusing.*

WARNING! THIS APPLIANCE MUST BE EARTHED.

IMPORTANT: The wires in the mains lead are colour coded in accordance with the following code.

Green and Yellow.....Earth

Blue.....Neutral

Brown.....Live

As the colours of the wires in the mains lead may not correspond with the markings identifying the terminals in your plug, proceed as follows.

- ① The wire which is coloured Green and Yellow or Green must be connected to the terminal which is marked with the letter 'E' or by the Earth signal  or which is coloured Green and Yellow or Green.
- ② The wire which is coloured Blue must be connected to the terminal labelled 'N' or coloured Black or Blue.
- ③ The wire which is coloured Brown must be connected to the terminal labelled 'L' or coloured Red or Brown.

Those units supplied to the North American market will have an integral moulded 3 pin connector which is provided to satisfy required local standards.

Front Panel Controls

5.0 Controls

5.1 Input section

Fig 5.1 Front panel

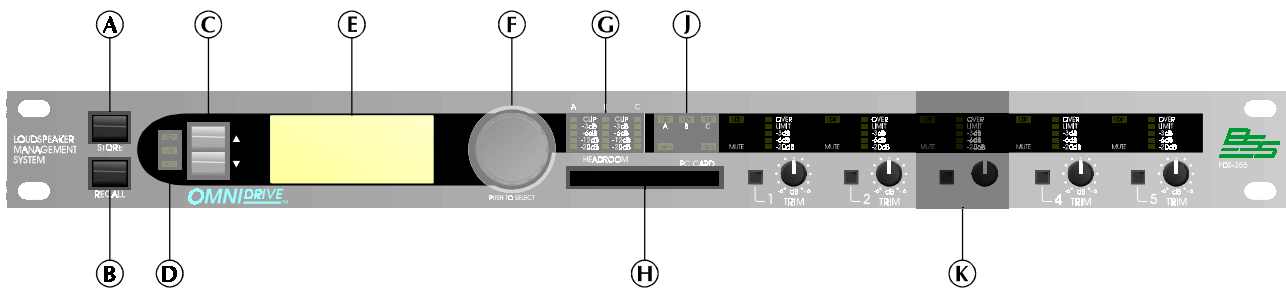

A Store key

Program data can be stored to either internal memory, or a PC card, and is done by using the store facility. The STORE key also doubles as an ENTER key for confirmation of some actions.

Refer to section 11.1; Storing

B Recall key

Program data is recalled to the unit from either internal memory or a PC card using the recall facility.

Refer to section 11.2; Recalling

C UP/DOWN Keys

Controller keys for editing parameters displayed by the LCD screen.

D Mode LEDs

Displays whether the FDS-355 is currently in Utils, Store or Recall mode.

E Main Display

The main LCD screen displays current parameters being edited with numerical and graphical representations. When the user is not editing, the screen can display the overall system response, or a custom logo.

F Encoder (Parameter wheel)

The encoder/parameter wheel is used in conjunction with the UP/DOWN keys to input or select information, and also to move between screens. Pushing and holding the wheel in will return you to the default screen after a few seconds. Pushing and holding the encoder, then pressing a mute button, will take the display to the corresponding output channel.

G Input meter

Input signal level referenced to the clip level. Actual signal clipping will occur slightly above the 'clip' indicator.

H PC card slot

The card slot is used for storing/recalling program data via a PC card.

Refer to section 16.0; PC Card for more information.

J Input LEDs

These indicate which (combination of) input channels are being edited. The Card LED underneath illuminates when a PC Card is inserted into the front panel slot.

Note: If all three input LEDs illuminate at once (which is highly unlikely), the unit is clipping internally due to large amounts of EQ or gain being added.

K Output controls

Refer to section 5.2; Output section for more detail.

Output section

5.2 Output section

Fig 5.2 Output section

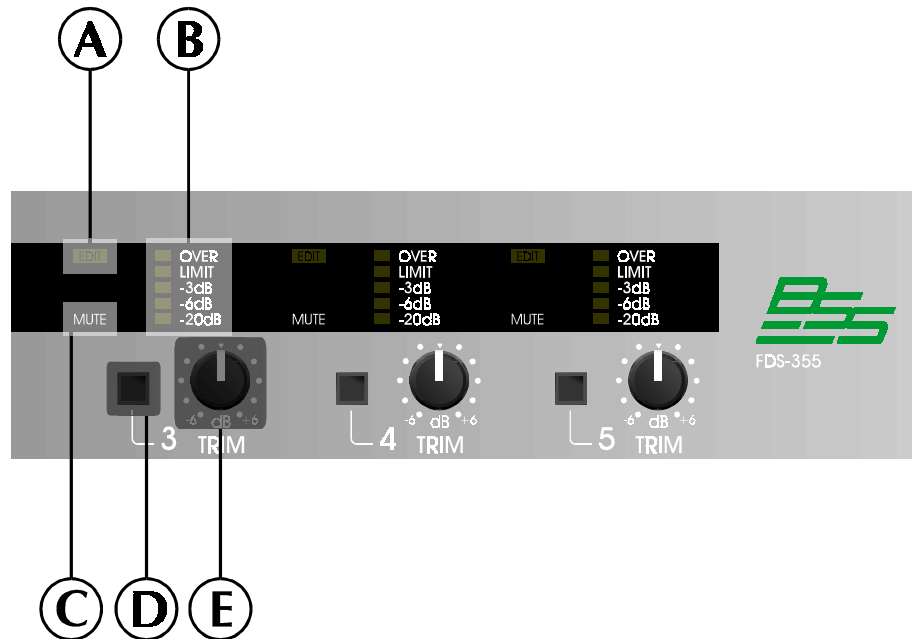

A Edit LED

Lights up when the output is being edited.

B Output meter

C Mute LED

Shows the mute status of the output band.

D Mute key

Pressing a mute key will toggle the associated band output on and off. The mute LED is illuminated when the output is MUTED. Mute status is saved when a program is stored.

E Gain trim

Each output band can be trimmed for output level across a range of -6dB to +6dB.

5.3 Rear panel

Fig 5.3 Rear panel

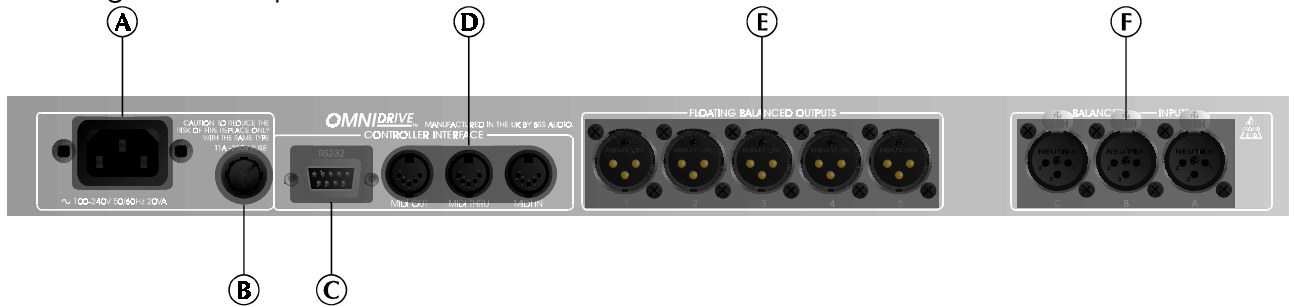

A Mains power input

The Power inlet for the FDS-355. Note that there is no On/Off switch for the unit.

B Fuse

C RS-232 connector

For connection to a PC for access to one or more FDS-355s on a MIDI loop, which provides an easy way to upload new software.

D MIDI interface connectors

E 5 Band outputs

The FDS-355 audio outputs are electronically balanced and floating. Transformer balancing is available as a retrofit option.

Pin 1	Shield/Ground
Pin 2	Signal Hot (+)
Pin 3	Signal Cold (-)

F 3 Channel inputs

The FDS-355 audio inputs are electronically balanced. Transformer balancing is available as a retrofit option.

Pin 1	Open circuit
Pin 2	Signal Hot (+)
Pin 3	Signal Cold (-)

Screen layout - Overview

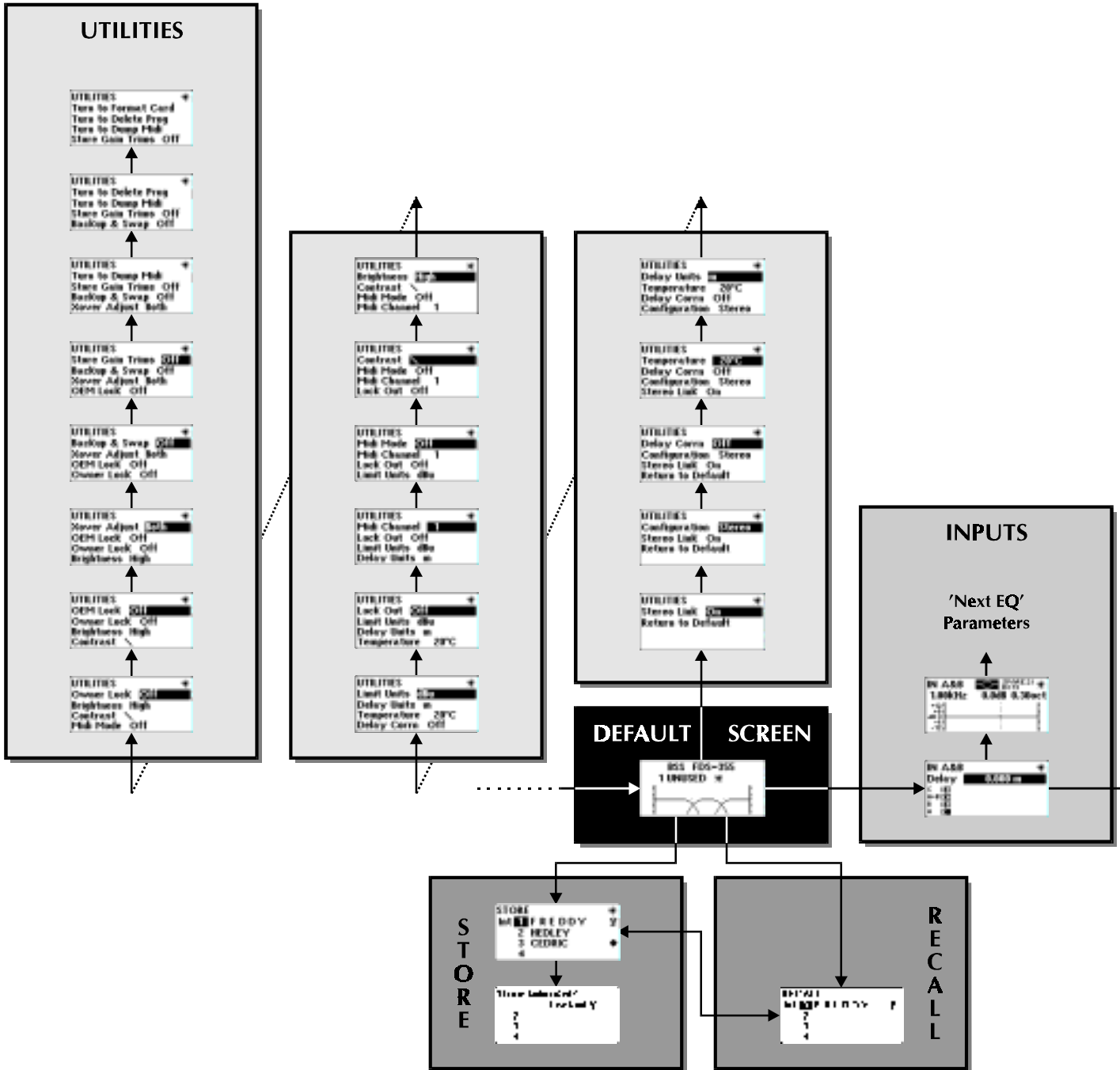

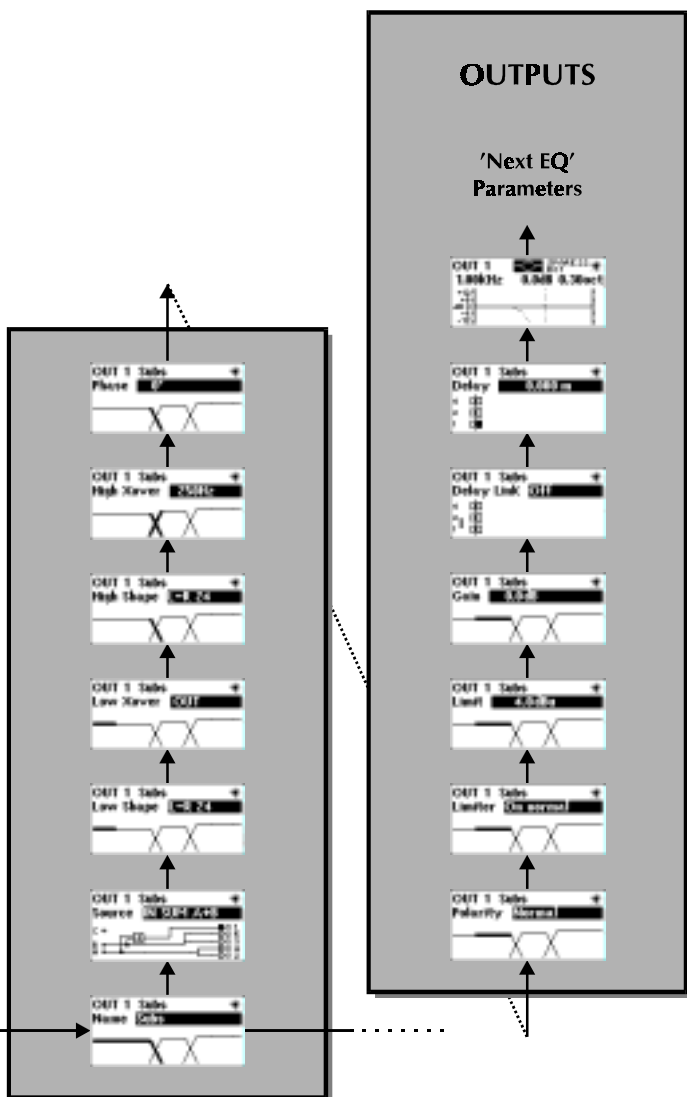

Moving about the screens

Use the parameter wheel to move between Default, Utility, Input and Output menus (Vertical columns). Pushing the wheel in, or pushing and holding the wheel in while turning clockwise, will move to the next screen on the right. Pushing and holding the wheel while turning anti-clockwise will move you a screen to the left. Each menu is shaded with a different colour to identify each separate menu structure. Pushing and holding the wheel in will return you to the default screen after a few seconds. Pushing and holding the encoder, then pressing a mute button, will take the display to the corresponding output channel.

Use the UP and DOWN keys to move up and down within each menu. The Utility and Output menus are displayed here in multiple columns since they have too many screens to display in one long column.

Moving to a new menu may not bring up the first (bottom) screen shown in each column, as the FDS-355 remembers, and moves you to, the last screen accessed in each menu.

Store and Recall are accessed by pressing their respective keys. **Refer to section 11.0** for more information.

Key screens

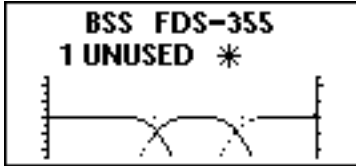

After powering up, the FDS-355 performs internal checks and sets up the audio path before releasing the output mute relays. This takes a few seconds.

Refer to section 6.0; Default screen.

Utilities

Pushing the UP key will enter the *Utilities Mode*. Many of the utility screens are self explanatory (see Screen layout on the previous two pages), but the more important ones are shown below.

The display shows the currently selected utility at the top of the screen, and the previous 3 available utilities underneath.

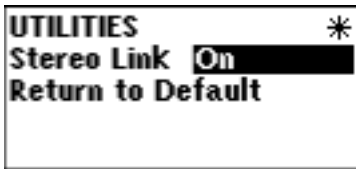

The stereo link screen shows whether the unit is operating in a linked mode or not.

Refer to section 7.0; Utilities menu.

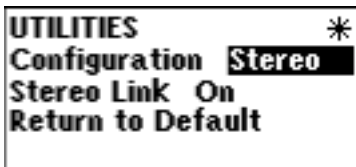

The configuration screen changes the output mode of the unit.

Refer to section 7.0; Utilities menu.

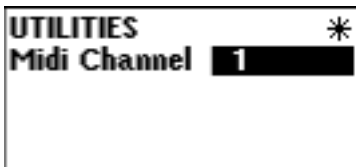

The MIDI details screens allows the user to select the MIDI channel and the MIDI mode of the unit.

Refer to section 7.0; Utilities menu.

Input settings

Pushing the parameter wheel again (at any time in the Default or Utilities menu) will enter *Inputs Mode*. Here the parameters of each input can be adjusted.

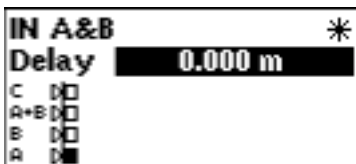

The delay screen shows the delay value set for each input.

Refer to section 8.0; Inputs menu.

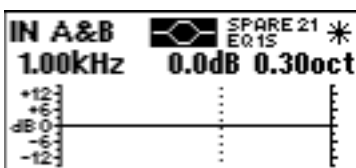

The next screen allows the user to edit the filter parameters in the following order: EQ shape, Frequency, Cut/Boost, and Width. Each filter is dealt with on a separate screen. Therefore, all of the first filter parameters will be accessed before moving on to the parameters of the second filter, and so on...

Refer to section 10.0; EQ screens.

Output settings

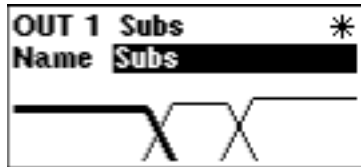

The name screen. Allows each output to be given a descriptive name from a preset list.

Refer to section 9.0; Outputs menu.

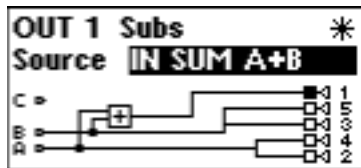

The source screen allows the user to configure the routing of the inputs to the outputs.

Refer to section 9.0; Outputs menu.

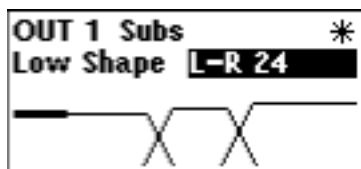

The Xover screens allow each edge of the crossover point to be adjusted, using the following parameters: Polarity, Phase, Low and Hi Filter shape, and Low and Hi crossover frequency.

Refer to section 9.0; Outputs menu.

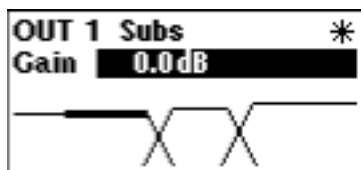

The Limiter and Gain screens allow output gain and limiter settings to be changed.

Refer to section 9.0; Outputs menu.

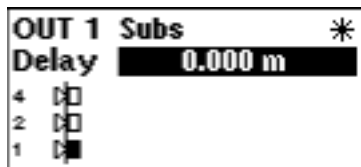

The Delay and Delay Link allow delay to be applied to the each output, and also allow linking for changing delay on multiple outputs simultaneously.

Refer to section 9.0; Outputs menu.

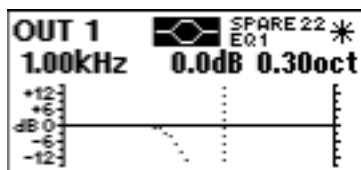

The next screen allows the user to edit the filter parameters in the following order: EQ shape, Frequency, Cut/Boost, and Width. Each filter is dealt with on a separate screen. Therefore, all of the first filter parameters will be accessed before moving on to the parameters of the second filter, and so on...

Refer to section 10.0; EQ screens.

Pushing the parameter wheel again (at any time in the Outputs menu) will return to the *Default/Utilities* screen.

Default screen

6.0 Default Screen

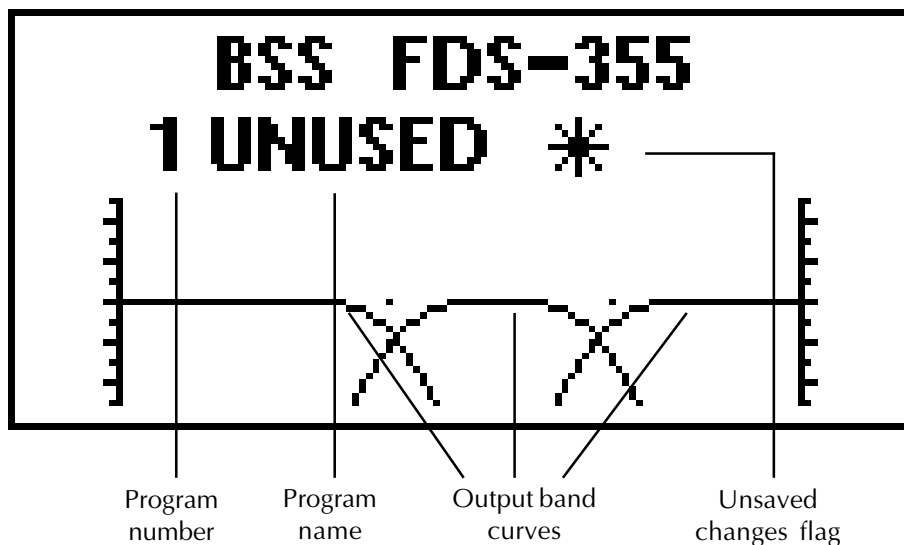

When the FDS-355 is powered up the Default Screen is shown. This gives a representation of the current state of the unit. If the unit has Lock Out mode ON, the Default screen will be replaced by the current start up logo, along with the current program name and number.

The main area of the screen contains the three output band curves. Each band curve represents the frequency response of the high and pass crossover rolloffs, in addition to any equalisation filters that have been used (and are not hidden).

The XOver frequencies are adjusted in the Outputs menus, **refer to section 8.0; Outputs menu.**

Equalisation can be adjusted in the EQ screen of the Inputs and Outputs menus, **refer to sections 10.0; EQ screens.**

7.0 Utilities Menu

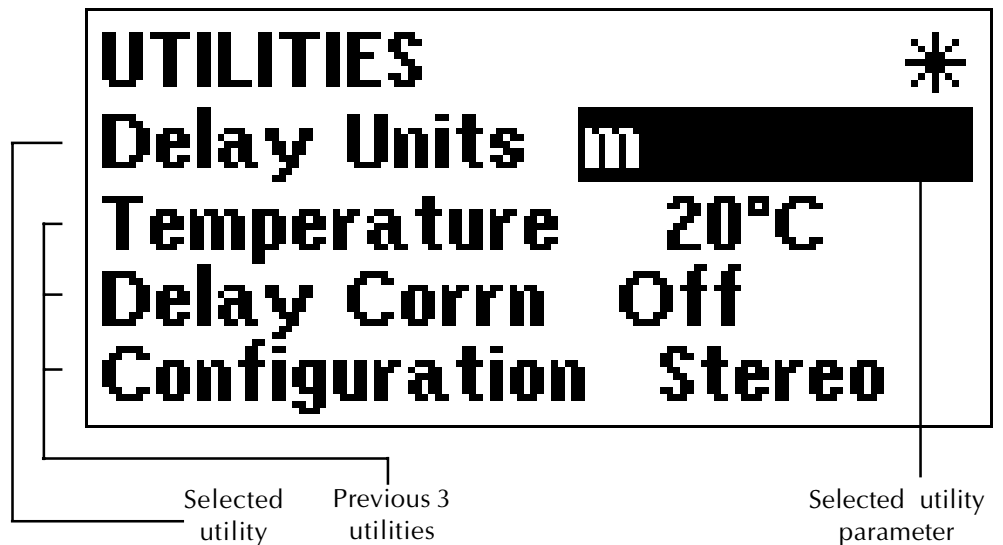

Pushing the UP key while viewing the default screen will move you into the Utilities menu. The UP and DOWN keys are used to move along the 'Utilities' path, and the parameter wheel is used to change the selected parameter. If confirmation of an action is required, the STORE key should be pressed. **Screens are shown here with only the described utility for clarity.**

Stereo link This mode selects whether parameters will be adjusted together, or independently on each channel.

Turning the parameter wheel clockwise selects Stereo Link: ON, and anticlockwise selects OFF.

Configuration The Configuration facility defines the general operating mode for the FDS-355; either Mono or Dual/Stereo 2-Way ("Stereo"). The parameter wheel is used to select the desired configuration.

The Mono mode (by default) assigns all outputs to input A, but it is possible to re-route any inputs and outputs after selecting a configuration.

By default, the stereo 2-Way mode will set up the unit as follows:

Input A (Left) to Outputs 2 & 4.
 Input B (Right) to Outputs 3 & 5
 Input C (Sub) to Output 1.

NOTE: When the configuration is changed, the unit will prompt for confirmation of the action. If the STORE key is pressed, then the mode will change, and DEFAULT VALUES WILL BE RESTORED. It is advisable to do a 'Store' before changing modes if you have set up a program.

Utilities menu

Delay correction Allows a delay correction to be entered, to compensate for ambient temperature. With Delay Corr set to 'Off', the default temperature is set to 20°C. Setting Delay Corr to 'Manual' allows a user defined value to be entered, from -20°C to 50°C, in 1°C increments. If Delay Corr is set to 'Midi', then the temperature value can be taken from a temperature probe connected to a 388. If the 355 is used with a single 388, then the 355 MIDI input should be attached to the MIDI output of the 388. **The 388 should be set to MIDI:XMIT MET.**

Temperature Sets the ambient temperature manually, if Delay Corr is set to 'Manual'.

Delay units This selects the units used for displaying and adjusting delays. 'ms' represents milliseconds, 'ft' represents feet (and feet and inches for short delays), and 'm' represents metres. 24, 25 and 30fps represent delays using 24, 25 and 30 frames per second respectively. Note that for longer delays, the resolution of the parameter wheel is reduced to match the number of decimal places displayed,. Short delays will adjust in approximately 11us increments, whilst longer delays will adjust in 100us increments.

Limit units The limit units screen allows the units of limiter threshold to be changed between dBu and mV, depending on your amplifier specification.

Lock out The Lock Out mode prevents access to editing functions on the input and output channels. Since this utility is not password-protected, Lock Out can still be accessed and turned off. This mode is intended only as a precaution against accidental adjustments, and not as a tamper-proof security lock
For other security details, *refer to section 17.0; System Security.*

MIDI channel Here, you can select the MIDI channel that the unit is assigned to (Channels 1 through 16 are available).

MIDI mode The selection of this mode sets what the FDS-355 may transmit on it's MIDI OUT socket, and depends on the use of the FDS-355 in the system. The possible selections are:

OFF

The OFF mode prevents MIDI messages being transmitted.

PROGRAM

The PROG mode enables the unit to transmit only MIDI program changes.

MASTER

The MASTER mode transmits all control changes to other devices on the same MID channel. (For paralleling two FDS-355s, for example).

THRU

The THRU mode allows the FDS-355 to pass incoming data on to it's MIDI OUT socket. (As required by the BSS MIDI network used in the FPC-900r and Soundbench systems).

PC PORT

The PC PORT mode allows the unit to be connected directly to a PC via the RS-232 port.

Contrast	This allows you to change the contrast of the LCD display.
Brightness	This allows you to change the brightness of the LCD display.
Owner lock	<p>The Owner Lock screen allows the owner of the unit to program a system and then lock the unit against being reset. Individual OEM locked parameters cannot be unlocked with the Owner Lock, and the owner cannot view OEM locked parameters.</p> <p>To enter Owner lock, change the lock status from OFF to ACTIVE. The unit will always prompt for the default password, which is 'OMNI' for Owner lock. Use the parameter wheel to cycle through characters, and the UP and DOWN keys (or push the parameter wheel) to change position in the password. Once the default password has been entered, press the STORE key to enter Owner lock setup mode. The screens for any parameter can then be accessed in the usual manner, turning the parameter wheel clockwise to lock the parameter. Once the setup is complete, press the STORE key again to save the owner lock setup. The unit will then prompt the user to enter a user password, and then press STORE again to confirm and exit Owner lock setup.</p> <p>To change Owner lock mode (from ACTIVE to OFF), the user Owner password must be entered.</p> <p>NOTE: There is no way to turn Owner lock off if the password has been forgotten! Refer to section 17.0; System Security for more information.</p>
OEM lock	<p>OEM Lock screen allows P.A. system manufacturers to lock the unit, so that certain parameters cannot be viewed and edited. OEM lock is the highest level of security of the unit, and can lock out any parameter of the unit.</p> <p>To enter OEM lock, change the lock status from OFF to ACTIVE. The unit will always prompt for the default password, which is 'BSS' for OEM lock. Use the parameter wheel to cycle through characters, and the UP and DOWN keys (or push the parameter wheel) to change position in the password. Once the password has been entered, press the STORE key to enter OEM lock setup mode. The screens for any parameter can then be accessed in the usual manner, turning the parameter wheel clockwise to lock the parameter. Once the setup is complete, press the STORE key again to save the OEM lock setup. The unit will then prompt the user to enter a user password, and then press STORE again to confirm and exit Owner lock setup.</p> <p>To change OEM lock mode (from ACTIVE to OFF), the User OEM password must be entered.</p> <p>NOTE: There is no way to turn OEM lock off if the password has been forgotten! Refer to section 17.0; System Security for more information.</p>
Xover adjust	<p>The Xover Adjust determines how crossover points are adjusted relative to the corresponding edge of the adjacent band. The following options may be selected:</p> <p>BOTH</p> <p>When set to BOTH, both the upper band edge of the lower band and the lower band edge of the upper band are adjusted as a pair. This means that only one filter adjustment is required to set a crossover point, and the graphic display shows both edges moving together.</p>

Utilities menu

NOTE: You can select either band in order to adjust the crossover - the lower band or upper band - and either adjustment will move both band edges together, updating the data for the other band.

EDGE

When set to Edge mode, each band edge is adjustable independently. This allows the possibility to create band overlaps at the crossover point.

Backup and Swap

Defaults to 'Off'. This function allows the user to make subtle adjustments to a setup, and then compare the changes to the original setup.

With this facility turned on, the store and recall buttons are reprogrammed to perform backup and recall respectively. Pressing the Store (Backup) button will copy the current setup to the internal clipboard. Changes can then be made to the setup, and then the Recall (Swap) button can be pressed to toggle between the two setups to compare them audibly. This function has no effect in the following circumstances:

- Immediately after boot-up, as the backup is empty.
- Immediately after the setup has been backed-up; since pressing the Recall (Swap) button toggles between two identical setups.

Note: Backup & Swap works only when a parameter of the program is being edited. I.e: When the unit is in an input or output mode.

With this option turned on, a Store or Recall can ONLY be performed from the default screen, or utilities menu.

Store gain trims

This feature allows the front panel gain trims values to be stored with the program. The 355 adds the front panel value to the band gain value for each output. Therefore, when recalling a program, **the unit will warn to set ALL front panel trim values to zero.**

(Turn to) MIDI dump

This mode allows you to dump the current program settings to another FDS-355, or a MIDI storage device for backup.

The default position for this screen is MIDI DUMP: NO. Turning the parameter wheel to YES will ask you to press STORE to confirm the dump. A percentage complete figure will show how much data has been transferred. When the dump is complete, the screen defaults to NO.

If you are using the MIDI Dump to transfer data to another FDS-355, ensure that both devices are set to the same MIDI channel, and connect the MIDI OUT of the sending device to the MIDI IN of the receiving device. The MIDI Dump mode is totally independent of the MIDI MODE.

NOTE: All parameter edits in all stored programs will be overwritten in any FDS-355 set to the same MIDI channel. Use MIDI Dump with care!

(Turn to) Delete program

This facility allow any stored program to be removed from the unit. Use the parameter wheel to select the desired program, and press STORE to confirm deletion.

(Turn to) Format card

For this mode to be enabled, a PC card must be present in the slot at the front of the unit. To begin the format, turn the parameter wheel clockwise, and the unit will prompt for STORE to be pressed to confirm the action. When the card is formatted, the screen will default to NO.

NOTE: ANY DATA ON THE CARD WILL BE LOST DURING A FORMAT.

8.0 Inputs Menu

There are three inputs available for routing to outputs plus an internal mono sum of inputs A and B, referred to as A+B. This gives the Input Channels:

A, B, A+B, and C.

The facilities described in this section are common to all inputs, except EQ, which is not possible on the mono sum A+B signal.

The first screen in the input menu is the DELAY SCREEN. Pressing the UP key will access the EQ screens.

Delay

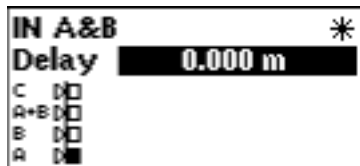

The delay on each input channel can be adjusted individually, in 11 microsecond steps. Turning the parameter wheel will set the amount of delay required on the input. This delay is typically used to set the delay for delay towers etc, or to stagger the delays between the left and right channels to 'move' sound lobes in an installation.

Delays can be viewed and adjusted in metres (default), feet/inches, or milliseconds. **Refer to section 7.0; Utilities menu.**

Note: The maximum delay value is restricted by any delay on an output which the current input feeds.

EQ

To add EQ to an input, step through the functions on the desired channel using the UP/DOWN keys until you reach the screen that shows the EQ parameter you wish to edit. **Refer to section 10.0; EQ screens** for more information on editing EQ parameters.

Outputs menu

9.0 Outputs Menu

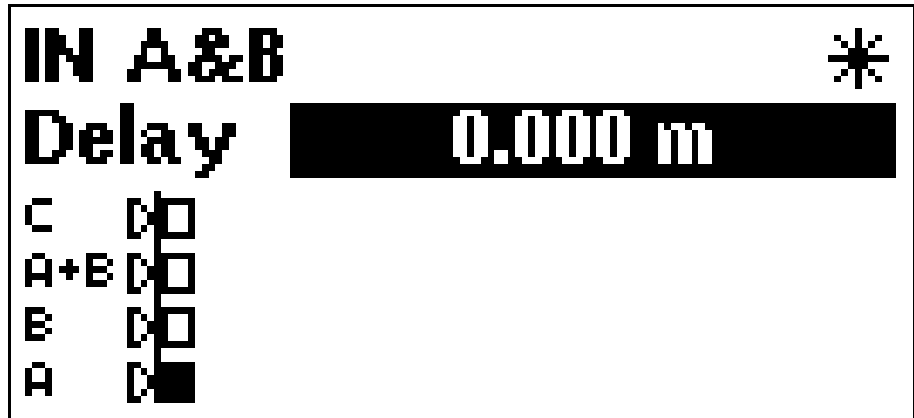

To select any one of the 5 output bands, press the parameter wheel until the output is shown on the screen, and the EDIT led above the desired channel illuminates. Pushing and holding the encoder, then pressing a mute button, will take the display to the corresponding output channel.

Name

The first screen in the Output menu is the Name function. Here you can identify each output with a name suitable to its function, selecting from a list of names in the FDS-355, such as SUB, or 2" HORN.

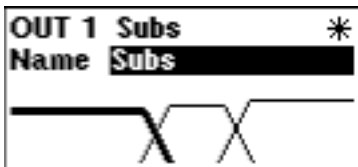

Turn the parameter wheel to select the desired name. If the name selected while stereo is NOT linked begins with L<space> or R<space>, then the L or R will not be displayed when stereo linking is on.

Source

This screen gives a graphical representation of the input to output assignment matrix. The channel selected has its speaker icon highlighted, and a connecting line shows to which input it is currently assigned. The input source name is also shown above the diagram.

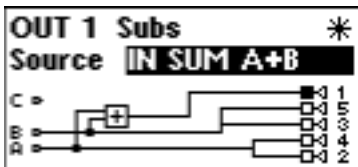

Note that the diagram shows straight through connections from inputs to outputs, omitting any internal processing (EQ, Xover etc) for clarity.

To change the source input, turn the parameter wheel until the speaker icon is connected to the desired source.

Note: The speaker icons are not drawn in a fixed order. The diagram will be drawn in the clearest way, to avoid lines crossing on the screen. Therefore care must be taken when changing input to output assignments, as the numbers next to the speaker icons (representing the outputs) will change positions.

Low shape

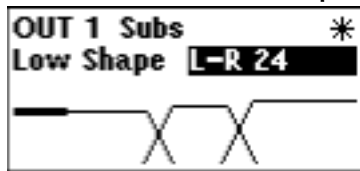

This screen is used to select the filter type/shape for the lower band edge (high-pass) of the current output band. The band edge will be highlighted on the graphic on the screen.

The available filter types are as follows, in this order:

- Butterworth 6dB / Octave
- Butterworth 12dB / Octave
- Bessel 12dB / Octave
- Linkwitz-Riley 12dB Octave
- Butterworth 18dB / Octave
- Butterworth 24dB / Octave
- Bessel 24dB / Octave
- Linkwitz-Riley 24dB / Octave
- Butterworth 48dB / Octave
- Linkwitz-Riley 48dB / Octave

Turning the parameter wheel will scroll through the above list.

Low Xover

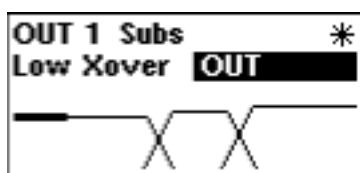

The lower edge (high-pass) of the crossover band can be set over a wide frequency range from OUT (no roll off) through 15Hz to 16kHz. Turning the parameter wheel anticlockwise will lower the frequency, with OUT as the final step. Turning it clockwise will increase the frequency, to the final clockwise position OFF, which mutes the output.

High shape

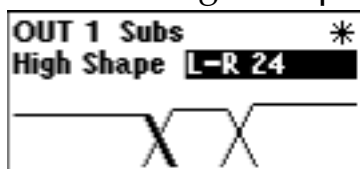

Selects the Edge filter type and slope as for the higher (low-pass) band edge.

High Xover

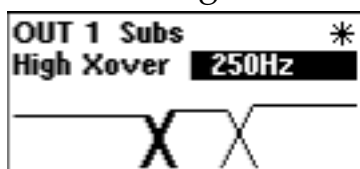

This function works in a similar way to the Low Xover, except that **OUT** is the last step at the **clockwise** position.

NOTE: Turning it clockwise will decrease the frequency, to the final clockwise position OUT, which **DOES NOT** mute the output.

Phase

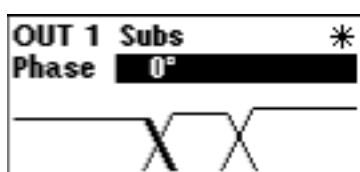

The phase relationship of the two band edges at the crossover point can be adjusted in 5 degree steps using this function. Adding any phase adjustment will utilise an EQ filter as described in **section 10.0; EQ screens**. The phase is adjusted by turning the parameter wheel.

The phase angle reference frequency is set by the high edge frequency so that this band controls the phase between the current band, and the band above it. Adjustments should therefore start with the highest band, and work downwards. Note that the topmost band(s) do not have an adjustable phase parameter.

Outputs menu

Polarity

The polarity invert function. Default is uninverted. Turning the parameter wheel clockwise will invert the polarity of the output. Turning anticlockwise will return the polarity to uninverted.

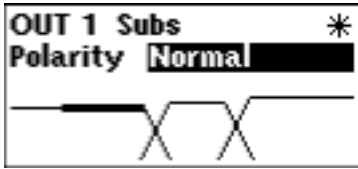

Limiter

The limiters can either be set to ON NORMAL, or ON FAST; the fast setting having a faster attack time. It is also possible to disable the protective limiters by turning the parameter wheel anticlockwise to toggle the display to OFF. When the limiters are turned OFF, the red OVER indicator will illuminate as a warning.

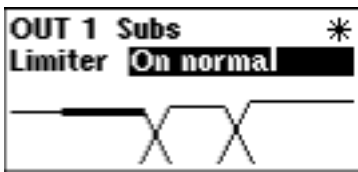

Limiter settings are preserved when a user saves a program - limiters will automatically be set to ON NORMAL if the limiters were on.

NOTE: BSS Audio cannot accept any liability for any damage caused by disabling the protective limiters in the FDS-355. This function is used totally at the discretion of the user.

Limiter threshold

With the limiters enabled, the band limiter threshold can be adjusted by turning the parameter wheel to set the desired value to match the sensitivity of the amplifier in use. The default units are dBu, but can be changed to mV. *Refer to section 7.0; Utilities menu* for details on how to change this.

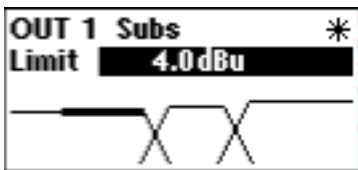

BSS Audio recommends setting the limiter thresholds below the amplifier clipping sensitivity by about 2dB. This prevents any transient overshoot driving the amplifier into clip and so damaging your loudspeakers. When limiters are disabled, the threshold setting determines the output meter sensitivity.

Band gain

To adjust the relative gain of the band output, turn the parameter wheel to achieve the desired level. This is independent of the output TRIM control on the front panel, and is additional to any level added by TRIM. Band Gain is stored as part of the program memory, whereas trim is not.

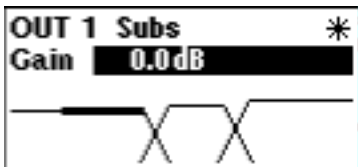

Delay link

The Delay Link option allows you to control several band delays with a single adjustment. This means that once all the drivers in a single cabinet have been aligned, the whole cabinet can be delayed relative to the input signal, or another cabinet, by linking these band delays as one. Any offsets applied before linking will be retained after linking.

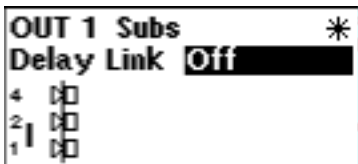

In the Delay Link screen, turn the parameter wheel until the desired linking configuration is shown. The linking setup is shown by a graphical representation, and is also described above the diagram.

Delay

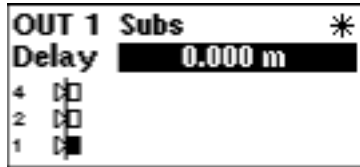

The band delays are most often used to electronically align the driver voice coils with the other drivers in the system, so the sound sources are coherent in the physical plane.

Each increment is only 11 microseconds, which translates in physical terms to a distance of 3.4mm, giving high accuracy in terms of alignment.

If delay units are set to f.p.s., then the value can be adjusted in half frame increments. The 355 will automatically convert the value of the delay, if delay units is changed from distance to f.p.s. in the utility menu, and vice versa. This also allows fine tuning once a value has been set in frames.

Turn the parameter wheel to move the icons left and right. The actual delay value is shown above the diagram, and the icons in the display represent the offsets between each output.

EQ To add EQ to an input, step through the functions on the desired channel using the UP/DOWN keys until you reach the screen that shows the EQ parameter you wish to edit. **Refer to section 10.0; EQ screens** for more information on editing EQ parameters.

EQ menu

10.0 EQ Screens

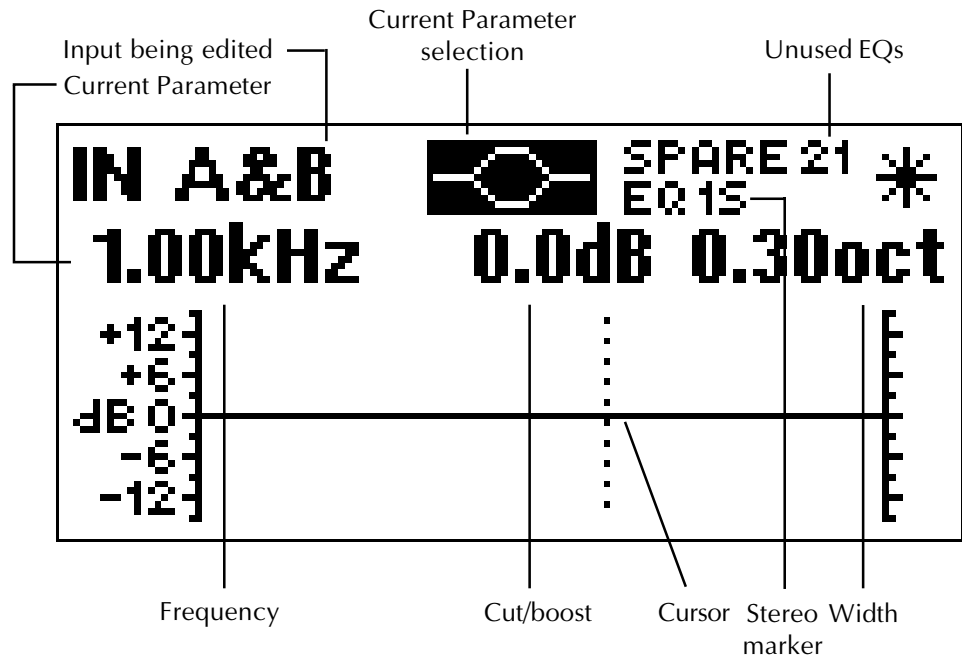

If the FDS-355 is configured for MONO, all EQ's will be mono. If configured for 2x2+1 ("stereo"), EQ's will be marked as Stereo 'S' when STEREO LINK is ON, and the stereo marker will show an 'S' next to the EQ number.

Available spare EQ filters are also shown above the graphic area.

Adding a new EQ:

If you press the UP key and the screen does not change, then you have reached the last EQ currently in use. To add an EQ, the cut/boost of the highest EQ must be edited. Another EQ (assuming there are spare EQs) will then be inserted automatically. A dotted contour shows the effect of the crossover filters on this band.

NOTE: The A+B signal is mixed after the EQ sections on A and B, so the A+B signal is affected by A and B EQ.

EQ shape

The shape of the EQ can be selected from one of the following by turning the parameter wheel:

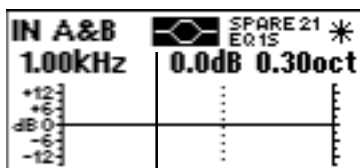

- Hi shelving with 12dB slope (Hi12)
- Hi shelving with 6dB slope (Hi6)
- BELL
- Low shelving with 6dB slope (Lo6)
- Low shelving with 12dB slope (Lo12).

The EQ shape icon at the top of the screen will change, to show the type of EQ selected.

Frequency

Turning the parameter wheel adjusts the EQ frequency. The filter position is shown graphically by the cursor, and the Frequency of EQs can range between 15Hz and 16kHz.

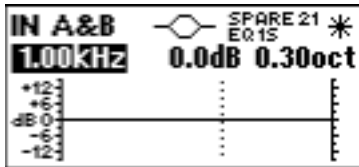

Cut/Boost

Turn the parameter wheel clockwise to add boost (+ gain) or anti-clockwise for cut (- gain). Cut/boost is available between +15dB and -15dB, in 0.2dB increments.

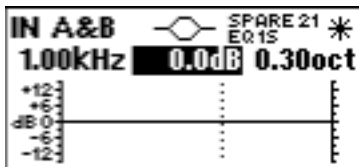

Width

Turning the parameter wheel clockwise widens the EQ (lower Q), anticlockwise makes the EQ narrower (higher Q). EQ Width is available between 0.05 and 3 Octaves, in 0.05 increments.

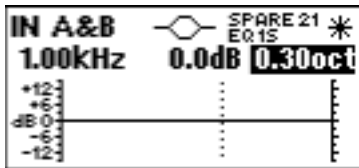

Store and Recall

11.0 Store and Recall

Storing and Recalling a program can be done at any time using the STORE and RECALL keys on the left hand side of the LCD, unless *Backup and Swap* (see section 7.0; *Backup and swap*) has been turned on. The FDS-355 can hold 60 programs internally, and these can also be saved to a PC card (refer to section 16.0; *PC Card*). At any time, the Default values of the unit can be restored by recalling program 0, except when Owner Lock is turned ON.

NOTE: If the unit is prompting for confirmation of an action at any time, the STORE key is used to conform the action, and pressing it at this point will not access the STORE facility.

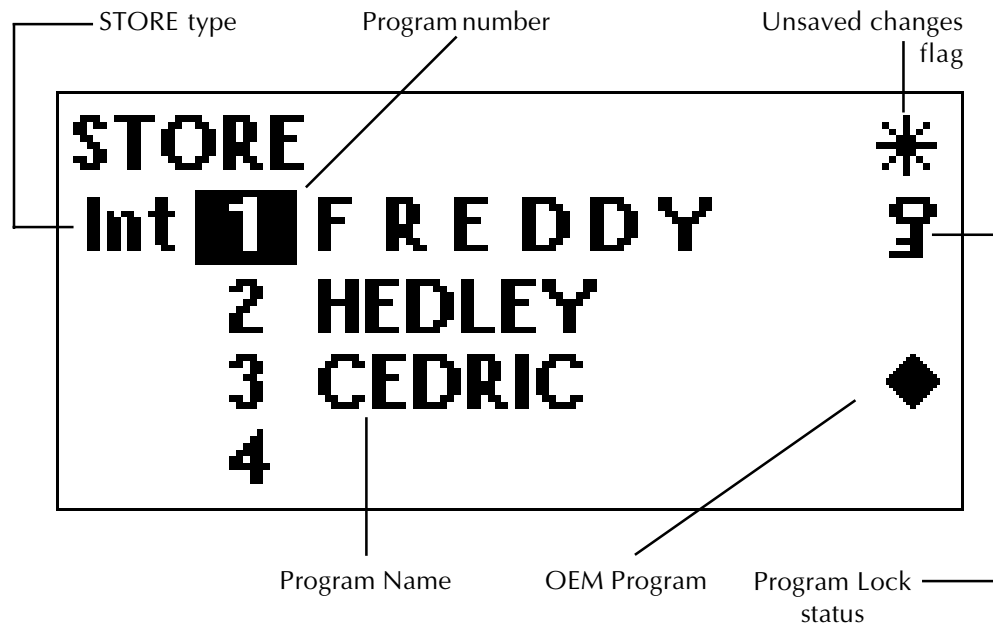

11.1 Storing Pressing the STORE key will access the Store screen.

Use the UP/DOWN keys (or push the parameter wheel) to move along the program name, and also between the program name and the STORE type at the top of the screen.

While the Program number is highlighted, turning the parameter wheel will cycle through programs 1-60.

While each of the letters in the Program name are highlighted, turning the parameter wheel will cycle through all available characters. Note that the letters in the program name being edited (at the top of the screen) are more spaced out than other program names on the screen.

The last space in the program name is reserved for Program lock. Turning the parameter wheel will turn this on/off. If a program has this flag set to on (so the program name displays a key at the right hand side), a new program, or edited version of the current program, cannot later be stored in this location. This lock can be turned off at any time in order to delete or overwrite the program. If you try to store a program in place of a locked program, the unit will display "PROGRAM LOCKED!", but will then highlight the key icon,

giving you the option to turn off the lock if you wish to overwrite the existing program.

STORE TYPE There are 3 ways in which data can be stored, and these are indicated by the STORE TYPE message at the top of the display. To highlight the Store type message, use the DOWN key while a program number is highlighted. Once highlighted, turn the parameter wheel to select the type of store you wish to use.

INT

This stores the program in the internal memory of the unit.

CPrg

This stores the currently selected program to a PC card (if inserted) in the slot at the front of the unit.

CALL

This stores all program data to a PC card (if inserted) in the slot at the front of the unit.

The Program Lock can be applied to a program stored using any of these 3 methods.

NOTE: The edit flag appears when there are unsaved changes to a program, compared to the initial status of the last recalled/stored program (Internal memory only). When a program is stored to internal memory, the edit flag will disappear. **If a program is stored to a PC card, then the flag will NOT disappear, since there are differences between the last recalled/stored program (Internal), and the current program.**

Once the program name has been entered, the store type selected, and the Program lock status cleared, pressing the STORE key again will prompt the message "STORE UNLOCKED?", asking whether the program should be stored with a Program lock on/off. Use the parameter wheel to turn the Lock on/off, the default setting being ON. Once the Lock status is set, push the STORE key a final time to commit the program to memory (or PC storage). The display will now default back to the screen displayed before the STORE facility was accessed.

To exit from the store screen without storing a program, press the recall button.

11.2 Recalling Pressing the RECALL key will access the recall screen. This facility is displayed in the same way as the store facility.

The parameter wheel is used to select the program number to recall (when highlighted), or to select internal memory or PC card recall (when highlighted). The UP/DOWN keys are used to toggle between Program number and Recall type.

When the program you wish to recall has been selected, push the RECALL key again to recall the program. The unit will display a message showing that data is being recalled, and will then display the default screen once the recall is complete.

To exit from the recall screen without recalling a program, press the store button.

Headroom Management System (HMS) Phase Compensation

12.0 Headroom Management System

Headroom Management System (H.M.S) is employed in the FDS-355 to make maximum use of the dynamic range of the devices inside the unit. In systems where limiter threshold levels are low, the output signal excursions are restricted, and thus make poor use of the available dynamic range.

HMS makes use of a variable gain stage in the digital domain, and a variable attenuation stage in the analogue signal path to change the gain structure. Whenever the limiter threshold or output gain is adjusted, HMS calculates the excess headroom and simultaneously increases both the digital gain, and the analogue attenuation to match. Since the Digital to Analogue Converter (DAC) and various other noise contributing components lay between these two adjustment points, the noise appearing at the output will be reduced.

Note that HMS is not a dynamic process; it only makes adjustments to the gain structure when the user makes adjustments. It is therefore free of side effects.

13.0 Phase Compensation

A classic 2-Way crossover using just a high-pass and a low-pass filter will always meet the criteria predicted for a given alignment. A 2-Way Linkwitz-Riley crossover, for example, will produce its two outputs 'everywhere in phase', and they will acoustically combine to a flat amplitude response. The main lobe of the polar response will also be on-axis.

When more filters are added to the crossover for more than two drivers, however, the crossover begins to depart from the mathematical perfection of the 2-Way case. In a 3-Way crossover, the high-pass characteristics of the mid band will be disturbed by the phase response of the low-pass in the mid band, and vice-versa. This results in drivers of adjacent bands being driven out of phase, producing irregularities in the amplitude response, and pushing the main lobe of the polar response off-axis, further aggravating amplitude response problems in some listening positions. Although these effects may be subtle when the crossover frequencies are well separated, 4 and 5-Way systems can produce significant errors.

The phase compensation scheme employed in the FDS-355 analyses these phase anomalies whenever adjustments are made, and introduces phase adjustment into certain bands such that the phase difference between all adjacent bands is always close to zero degrees. It will of course allow the user to introduce intentional phase differences, using the *phase* and *delay* parameters. The FDS-355 will not attempt to apply phase compensation if the high and low frequencies or shapes of the adjacent bands do not match, on the assumption that the user does not expect to produce a standard alignment.

14.0 Typical Applications

The FDS-355 has three inputs: A, B, C. An internal mono sum of inputs A & B is also available for routing to any of the outputs. Any combination of routing inputs to outputs is available, and the FDS-355 can be configured as a stereo or mono device.

14.1 Stereo 2-Way with a mono sub-bass.

Systems can be run as simple stereo 2-Way, or with an additional sub-bass output (Mono). This sub-bass can be derived from either a mono sum of the stereo inputs, or from a separate input using an aux send from the console.

To use the FDS-355 in this mode, configure the unit as 2 X 2+1 (stereo) in the Configuration screen of the Utilities menu.

Use inputs A and B for the stereo inputs, and Outputs 2-5 for the Output bands (Bands 2 and 3 are Lo left and right, and bands 4 and 5 are Hi left and right respectively). The sub output 1 should be sourced from the mono sum A+B, or input C for an independent sub-bass feed.

The Stereo Link ON mode allows the same parameters on the left and right channels to be adjusted simultaneously and any edits made Unlinked are preserve the left/right difference as an offset.

14.2 Dual Bi-amp (Stage monitors)

The FDS-355 can provide 2 channels of bi-amp crossover for monitor racks with EQ, delays, and limiters. With so much EQ available in the FDS-355, it is easy to assign 12 bands of EQ to the input, as well as EQ to the output bands, saving the need for external EQ.

For example: Input A would feed Outputs 1 and 2, with Input B feeding outputs 3 and 4. Set the configuration to Mono in the Utilities menu, and adjust the SOURCE mode accordingly.

In this mode, it is possible to remove 'hot spots' on stage. Where the same mix is sent to a number of performers, interaction between wedges can create lobes of high intensity which creates confusion. Using a fine delay to shift wedge feeds can move these hot-spots to less sensitive areas on stage.

14.3 5-Way zoning distribution

The FDS-355 can be also be used as a zone distribution system, without using any of its crossover facilities. Using this mode, a common input signal can be routed to up to 5 separate outputs, each with delays, EQ and limiters.

Typical uses for this mode would include feeding a number of under-balcony loudspeakers with integral passive crossovers, using the delays of the FDS-355 for time correction, and EQ for tuning response. For this application, each output should be full range, unless you particularly want to band restrict the outputs.

Use the Xover Freq screens in the Outputs Menu to set each band edge to be OUT.

Typical Applications

14.4 Mono 5-Way In the mono mode, the FDS-355 can provide a full 5-way system. It can also function as a 4-way system fed from input A, with an independent sub-bass output fed from input C (or B). Two FDS-355s working in this mode can form a stereo 5-way system.

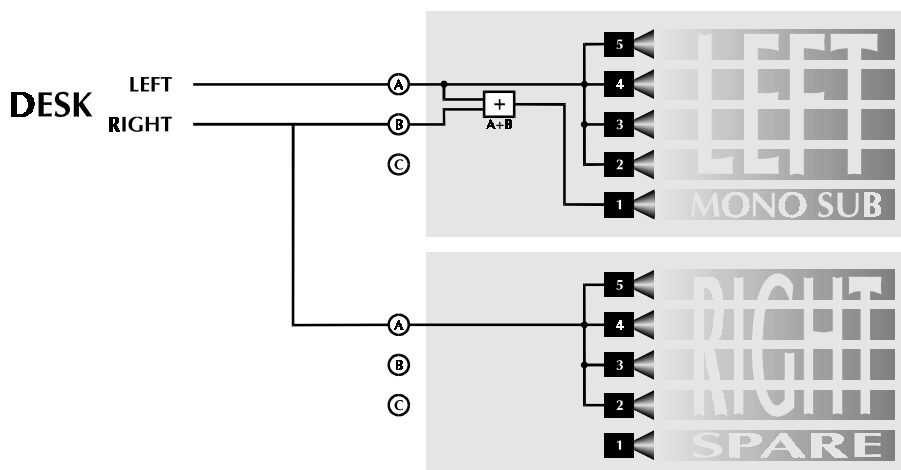

15.0 Quick Reference - How to ...

15.1 Use delays to Time align® drivers

The best way to do this is to have a good idea of the physical positions of the voice coils of the drivers in the cabinet. If you do not know this, an estimate can be made, but it may take a while longer.

Assume a 3-way box; with a 12" direct radiator, a 2" horn with a compression driver, and a 1" bullet.

The voice-coil furthest away from the front of the cabinet will be the 2" horn, so the other two drivers will need delaying to compensate for the time it takes the audio energy to reach the outer flare of the horn. This distance could be 300mm. Subtract from this the distance of the voice coil of the low driver (lets say 120mm) and set that delay to the result (180mm). Do the same for the 1" bullet, which will usually have a shorter distance from voice coil to front, and hence need a longer delay.

15.2 Keep relative delays while delaying a group

This is achieved by using the DELAY LINK mode. Any bands can be linked so that a delay applied acts to all the linked bands. This means that relative shifts between cabinets can be made without upsetting driver alignments.

Select the output band to be linked in the outputs menu, then use the UP key to cycle through the screens until the Delay Link screen is shown. Turning the parameter wheel will show all possible choices, which are determined by the bands sourced from the same input. The graphic display will also show the bands being linked.

15.3 Name a band

The FDS-355 has a preset list of names you can select from which may suit your system layout. For example, *Output 1* can be renamed to *Subs*.

To do this, select Output 1 by pushing the parameter wheel. Once the Output 1 screen has been selected, use the DOWN key to select the Name screen (if not already shown). Turn the parameter wheel to select a relevant name for the output. The name is automatically retained when a new screen is selected.

15.4 Make a band full range

In the utilities menu, the Xover mode must be changed from 'Xover' to 'Edge'. Then select the band to be edited by pushing the parameter wheel. Use the UP/DOWN keys to cycle to the Xover Frequency screen for the lower band edge (Low Xover). Turn the parameter wheel anti-clockwise until the display reads OUT, and the graphic shows the lower edge horizontal, with no roll-off. Pressing the UP key twice will access the upper edge Xover Frequency screen. Turn the parameter wheel clockwise until the display reads OUT, and the band is shown as completely flat.

The band is now full range.

Quick Reference - How to ...

15.5 Add EQ for Constant Directivity horns

Constant Directivity horns often require additional equalisation in order to extend their frequency response. In most cases, this is a fairly simple EQ, requiring only a gentle slope (6dB per octave) high-pass shelving filter.

To add CD EQ, select the band to be equalised by pushing the parameter wheel, and push the UP/DOWN keys until you reach a free EQ band **refer to section 10.0; EQ screens.**

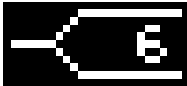

Select a 6dB, Hi Pass filter by turning the parameter wheel until the shape icon at the top of the screen shows the graphic shown left.

Push the UP key to access the EQ Frequency, and adjust the freq by turning the parameter wheel to show a frequency of about 2kHz (check with your manufacturer for detailed information about Frequency and Boost requirements for a system).

Push the UP key to access the EQ Cut/Boost, and turn the parameter wheel to give a boost of about 6dB.

The frequency and boost values may need trimming to give the best results.

15.6 Loading custom logos

Custom logos can also be loaded into the 355 using the latest BSS loader (available from the web site). These logos must be in .GIF (87a non-interlaced) format. The resolution of the 355 screen is 128x56 pixels, and 2 colours. Logos should be drawn with a white tool on a black background.

16.0 PC Card

The PC Card socket on the front of the unit is designed to use memory cards of between 128kbyte and 2Mbyte storage capacity. Files are stored on the card in a 'Pseudo-floppy' format using standard DOS structures. See the box at the end of this section for compatibility information.

16.1 Card types The Smart Card interface requires 68pin compatible SRAM memory cards. Attribute memory is not required and is not used. The most appropriate card size for the FDS-355 is the 256k byte card which can hold approximately 14 complete setup (CAL) files.

SRAM CARDS 128k, 256k, 512k, 1M, 2M. Battery life varies with manufacturer and memory size and should be checked with the card supplier.

Rechargeable cards are also now available. These cards should periodically be left in the card slot of an FDS-355 for a few hours to recharge. Expected battery life for rechargeable cards when not plugged into a unit is about one year, but should always be checked with the card supplier.

16.2 PC Card format The PC Card filing system on the FDS-355 uses a 'pseudo-floppy' format. Formatting a Card on the FDS-355 writes a standard PC DOS format to the card beginning at byte 0 as if it were the first byte on a disc. The format writes a DOS boot sector with basic format data but does not write boot software. This is followed by a single File Allocation Table (FAT) starting at byte 200H. The root directory is written with one entry, a sub-directory called BSSDATA. All data files used by the unit are stored in the BSSDATA sub-directory as there are limits to the number of files that can be stored in the root directory.

The different file types used by the unit have different file extensions as follows. The file sizes are variable, and change with the number of EQs used, and number of programs.

Program	*.CPG
All data	*.CAL

The 'pseudo-floppy' filing system as used on the unit conforms to the PC CARD standard although it does not format Card Information Structure (CIS) information. BSS has tested and developed the Card filing system using an IBM compatible PC card reader and a range of palm-top computers, but cannot guarantee that the cards can be read by any particular piece of computer equipment. **To be able to transfer files to and from an external computer note the following:**

- Always format the card on the external computer.
- Always write a sub-directory called BSSDATA into the root directory immediately after formatting the card. All files used by the FDS-355, FDS-388 and FPC-900 remote are stored in the BSSDATA sub directory.

System Security

17.0 System Security

Any changes made to an audio system have the potential to be damaging, even if only accidentally made. For this reason several different security systems are built in to the FDS-355 to protect the speakers.

Each of the security levels locks different groups of variables away from accidental or malicious adjustment.

17.1 Program lock This is a flag that is available for each stored program. A program can be locked when it is stored - the user is prompted when Store is pressed for the second time.

Locking a program in this way is purely to protect the user against accidentally overwriting a stored file. The lock status can be changed by anyone unless the program is OEM locked (see next page).

17.2 Lock mode The Lock Mode in the Utility Menu can be turned on at any time.

When Lock Mode is set to ON, no variables can be changed except for the Display Angle and Backlight and, of course, the Lock Mode. The user can move around the screens to look at any variable but only the front panel gain trims and mutes are available to be adjusted. When Lock Mode is ON, the Default Screen will display the unit's logo along with the current program number and names.

Locking the unit in this way is only to protect the user against other users changing the system setup accidentally or against unauthorised people intentionally changing the system. This status can be changed by anyone who knows how to operate the FDS-355.

17.3 Owner lock The Owner lock mode gives the user the privilege of being able to hide selected parameters from other users view and prevent those parameters from being tampered with. A password is entered by the engineer to protect the integrity of the locked parameters, and this password is necessary to subsequently gain access to the Owner locked parameters and to the parameter locking mechanisms. The end user may then use the locked Owner program as a basis for operating a system, and make further modifications to the setup, to an extent completely controlled by the designer.

To set Owner Lock (Utilities menu) ACTIVE, the user will be asked to enter the default password, which is 'OMNI' for Owner lock. The use of a default password is to prevent accidental or malicious setting of lock flags. The user enters the default password by turning the parameter wheel to change each letter, and either press the UP/DOWN keys, or push the parameter wheel to move along the password. The user should then press STORE to enter the default password, or push the parameter wheel until the cursor reaches the end of the password.

Once in the Owner Lock Screen the owner can move around the screens in the usual manner, but turning the parameter wheel will now toggle Owner Lock on/off for the current screen (shown by a padlock icon in place of the current value). At the 'end' of the used EQs screen, there is an option to 'Lock extra EQs'. This option gives the owner the ability to prevent any user without the correct password from entering any further EQs onto that channel. Once

the required parameters have been locked out, the STORE key should be pressed again - prompting for a user password to be entered.

The action of pressing the STORE key a final time is to exit Owner Lock setup mode, leaving the Owner Locks in place, ready for the user.

The owner can set more locked parameters by turning Owner Lock from *active* to *off* (utilities menu) using the user password, and then back to *active* (which requires the default password) to start setting owner locks.

NOTE. To store a program as an Owner program, the unit MUST be in Owner Lock setup mode when the program is stored, otherwise the stored program will not be identified as an Owner program in the program list. This lock mode can only be changed by people who know the Owner Lock password. Be warned that it is impossible to unlock a unit where the password has been forgotten.

17.4 OEM lock

The OEM lock mode gives the user the privilege of being able to hide selected parameters from other users view and prevent those parameters from being tampered with. A password is entered by the OEM engineer to protect the integrity of the locked parameters, and this password is necessary to subsequently gain access to the OEM locked parameters and to the parameter locking mechanisms. The end user may then use the locked OEM program as a basis for operating such a system, and make further modifications to the setup, to an extent completely controlled by the OEM designer.

To set OEM Lock (Utilities menu) ACTIVE, the user will be asked to enter the default password, which is 'BSS' for OEM lock. The use of a default password is to prevent accidental or malicious setting of lock flags. The user enters the password by turning the parameter wheel to change each letter, and either press the UP/DOWN keys, or push the parameter wheel to move along the password. The user should then press STORE to enter the default password, or push the parameter wheel until the cursor reaches the end of the password.

Once in the OEM Lock Screen, the user can now move around the screens in the usual manner, but turning the parameter wheel will now toggle OEM Lock on/off for the current parameter (shown by a diamond in place of the current value). At the 'end' of the used EQs screen, there is an option to 'Lock extra EQs'. This option gives the OEM engineer the ability to prevent any user without the correct password from entering any further EQs onto that channel. Once all parameters have been locked out, the STORE key should be pressed again - prompting for a user password to be entered. The action of pressing the STORE key a final time is to exit OEM Lock setup mode, leaving the OEM Locks in place, ready for the user.

The owner can set more locked parameters by turning OEM Lock from *active* to *off* (utilities menu) using the user password, and then back to *active* (requiring the default password) to start setting OEM locks. The password will have to be entered a second time to set more OEM lock flags.

When OEM programs are stored, they are automatically program-locked, and identified in the program list by a diamond. The OEM program lock status cannot be undone by the program lock utility, but an OEM program may be overwritten by another OEM program with the same OEM password, as long as the overwriting program is an OEM original.

System Security

For example, recalled OEM program 1 cannot immediately overwrite program 1, even if the same OEM password is used, and the message 'Program Locked' will appear. The OEM Lock must first be turned off, and then turned back on again (using the same password). Now if the program is stored over program 1, the STORE facility will allow the program to be overwritten.

NOTE. To store a program as an OEM program, the unit MUST be in OEM setup mode when the program is stored, otherwise the stored program will not be identified as an OEM program in the program list. This lock mode can only be changed by people who know the OEM Lock password. Be warned that it is impossible to unlock a unit where the password has been forgotten.

17.5 Safe The FDS-355 has a hidden function called SAFE. SAFE mode is intended to be used as a complete lock-out for installations or as the ultimate protection for hire systems etc. When SAFE mode is switched on, all controls are disabled, the screen blanks and the backlight adjusted to dim. With SAFE mode ON the meters still run but no one can change any values within the unit.

The user must be aware that any adjustments made to the gain controls whilst in Safe will not be heard until Safe is turned off.

As the SAFE mode is intended for security, the details of its use can not be published here. Please consult your dealer for further information on SAFE mode.

18.0 Troubleshooting

Problem: Unit does not power up.

Solution: Check power cable is inserted properly at back of unit.
Check the fuse at the rear of the unit has not blown.

Problem: No output.

Solution: Ensure mutes are not active.

Problem: All 3 Input LEDs light up at once.

Solution: The unit is clipping internally. Reduce EQ or gain.

Problem: A new program will not save over an existing program.

Solution: Check that the existing program is not locked. If it is, clear the key icon by turning the parameter wheel. If the program is OEM locked, the overwriting program must have the same OEM password, and be an OEM original program.

Problem: The LCD graphics are not clear enough.

Solution: Use the brightness and contrast options in the Utility menu to change the LCD display.

Warranty Info

19.0 Warranty Information

When sold to an end user by BSS Audio or a BSS Audio Authorised Reseller, this unit is warranted by the seller to the purchaser against defects in workmanship and the materials used in its manufacture for a period of one year from the date of sale.

Faults arising from misuse, unauthorised modifications or accidents are not covered under this warranty. No other warranty is expressed or implied.

If the unit is faulty it should be sent to the seller of the equipment, in its original packaging with shipping prepaid. The unit will be returned to you when the repair has been completed. If the unit was purchased in the European Union, you may, as an alternative, return the unit to any other BSS distributor in the European Union.

You should include a statement listing the faults found. The unit's serial number must be quoted in all correspondence relating to a claim.

IMPORTANT

We recommend that you record your purchase information here for future reference.

Dealer Name: _____

Dealer Address: _____

Post/Zip Code: _____

Dealer Phone No.: _____

Dealer Contact Name: _____

Invoice/Receipt No.: _____

Date of Purchase: _____

Unit Serial Number: _____

In keeping with our policy of continued improvement, BSS Audio reserves the right to alter specifications without prior notice.

The **Omnidrive** was designed and developed by BSS Audio, Hertfordshire, England.

Phone (+44) (0)1707 660667. Fax (+44) (0)1707 660755.

World Wide Web address: <http://www.bss.co.uk>

20.0 Specifications and Block Diagram

- Dynamic Range** Typically >106dB, Analogue Input/Output, unweighted 22Hz to 22kHz
- Frequency Response** $\pm 0.25\text{dB}$, 15Hz-20kHz with filters out
- Distortion (THD)** <math>< 0.01\%</math>, 20Hz-20kHz @+10dBu
- Inputs** Electronically balanced & floating (Transformer balanced option)
- Input Impedance** 10k Ω
- Maximum Input Level** +20dBu, balanced
- Outputs** Electronically balanced & floating (Transformer balanced option)
- Maximum Output Level** +20dBu into 600 Ω
- Channel Separation** >80dB, 20Hz-20kHz
- Power Supply** AC Mains 50/60Hz, 90V - 264V
- Power Consumption** <math>< 30\text{VA}</math>
- Options:** Input balancing transformers
Output balancing transformers

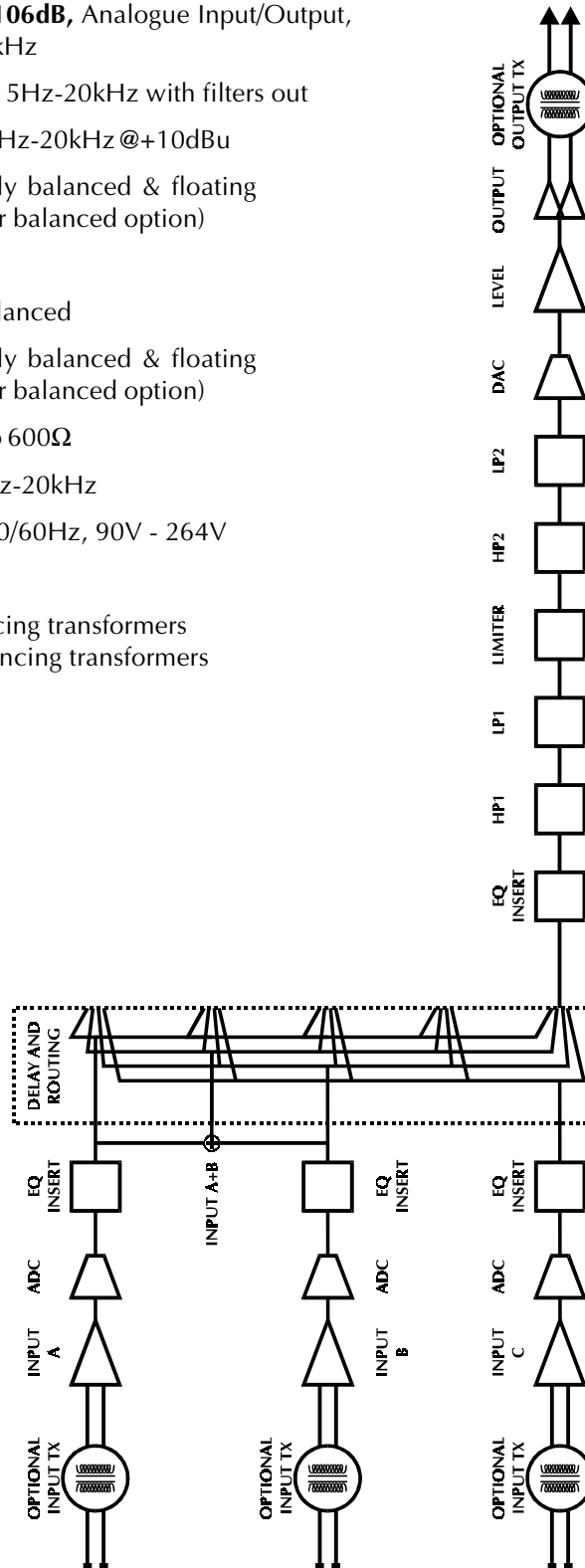

Note: All Output bands are identical

Index

Index

A		shape	30
		width	31
Applications		EQ screens	18
5-Way Zoning Distribution	35	EQ shape	30
Dual Bi-amp	35		
Mono 5-Way	36	F	
Stereo 2-Way with a mono sub-bass	35	File Allocation Table	39
		Frequency	
		EQ	31
		Xover	27
		Full range band	37
		Fuse	15
B		G	
Backup	24	Gain trim	14
band gain	28	Gain trims	
Block Diagram	45	storing	24
Brightness	23		
		H	
		Headroom Management System	34
		I	
C		Input LED	13
CD Horns		Input meter	12
adding EQ	38	Inputs	15
Clipboard	24	delay	25
Clipping		Installation	10
input level	12		
internal	13	L	
Configuration	18	LED	
Contents	3	input	13
Contrast	23	mode	12
Cut/Boost		Limiter	28
EQ	31	threshold	28
		Lock	
D		OEM	23, 41
Default screen	18, 20	owner	23, 40
Default values		program	40
restoring	21	Lock extra EQ	40, 41
Delay	18	Lock mode	40
correction	22	Logo files	39
input	25		
output	29	M	
Delay Link		Main Display	12
output	28	Mains fuse	9
Delete program	24	Meter	
Down Key	12	input	12
		output	14
E			
Edit LED	14		
Encoder	12		
EQ	30		
adding a new EQ	30		
Cut/Boost	31		
frequency	31		
lock extra	40, 41		

MIDI			
connectors		15	
details		18	
dump		24	
setting channel number		22	
setting mode		22	
Mode LED		12	
Mono mode		21	
Mute key		14	
Mute LED		14	
O			
OEM Lock		41	
Output			
band gain		28	
delay		29	
Delay (Link)		19	
delay link		28	
EQ		19	
Gain		19	
High Xover freq		27	
High Xover shape		27	
Limiter		19	
limiter		28	
limiter threshold		28	
Low Xover freq		27	
Low Xover shape		27	
name	19, 26		
Phase		27	
polarity		28	
source	19, 26		
Xover		19	
Output meter		14	
Output section		14	
Outputs		15	
P			
Parameter wheel		12	
PC Card			
card types		39	
formatting	24, 39		
slot		13	
Phase		27	
Compensation		34	
Polarity		28	
Power			
AC Fusing		9	
connection		11	
inlet		15	
Program files		39	
Q			
Quick reference		5	
adding EQ for CD Horns		38	
Keeping relative delays		37	
Making a band full range		37	
Naming a band		37	
Time aligning drivers		37	
R			
Rack space			
requirements		10	
Rear panel		15	
Recall		32	
key		12	
Recalling			
from a PC Card	5, 33		
RS-232 connections		15	
S			
Safe mode		42	
Screen layout			
overview		16	
Source		26	
Specification		45	
Stereo			
2-Way mode		21	
link		18	
Store		32	
key		12	
to a PC Card		33	
Swap		24	
System security	40, 43		
Lock Mode		40	
OEM Lock		41	
Owner Lock		40	
Program lock		40	
Safe mode		42	
T			
Temperature		22	
U			
Unpacking		9	
Unsaved changes		20	
UP key		12	
Utilities			
brightness		23	
Configuration		21	
Contrast		23	
Delay Units	21, 22		

Index

delete program	24
Format PC Card	24
Limit Units	22
Lock Out	22
menu	18
MIDI channel	22
MIDI dump	24
MIDI mode	22
OEM Lock	23
Owner Lock	23
Xover mode	23
V	
Voltage setting	9
W	
Warranty info	44
Width	
EQ	31
Wiring convention	15
X	
Xover	
adjust	23
Output - High freq	27
Output - High shape	27
Output - Low freq	27
Output - Low shape	27

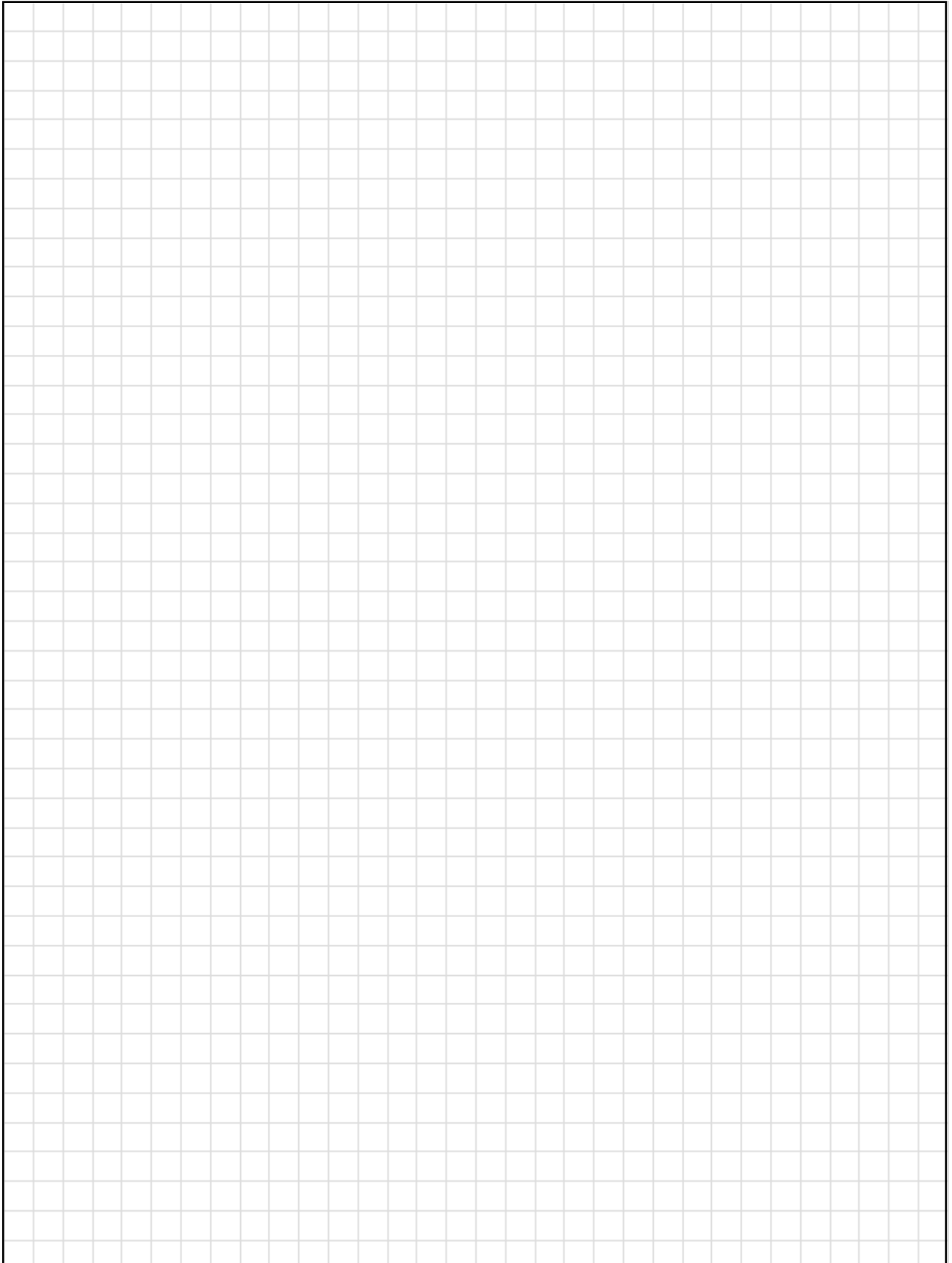

User Notes

A large rectangular area filled with a light gray grid pattern, intended for users to write notes or take measurements. The grid consists of small, uniform squares.

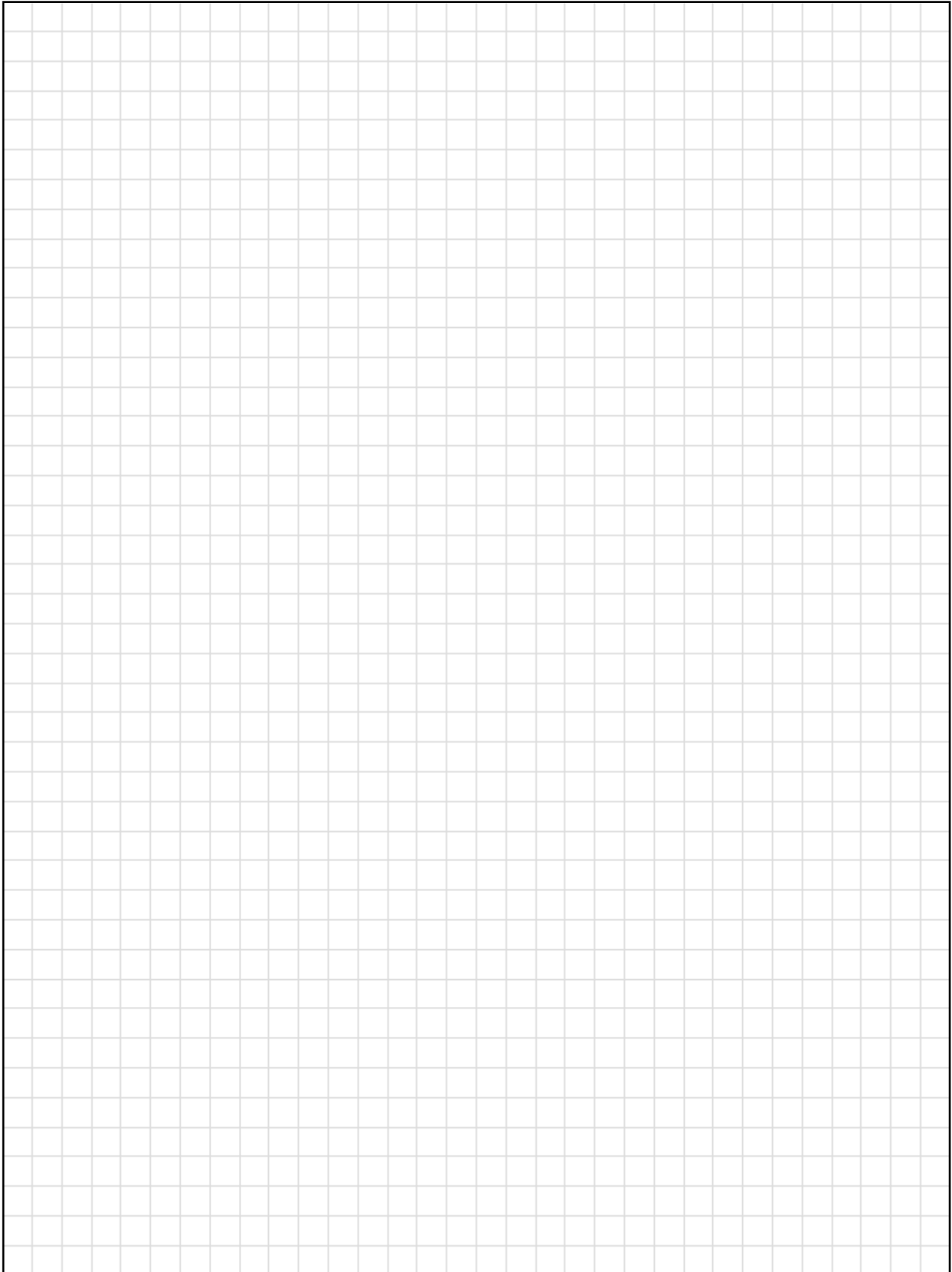

User Notes

A large rectangular area filled with a light gray grid pattern, intended for users to write notes or take measurements. The grid consists of small, uniform squares.