

flexible

coherent

efficient

scalable



CD18 CONTROLLED DIRECTIVITY SUBBASS

PRODUCT FEATURES

Unique directional subbass with cardioid or supercardioid pattern keeps subbass energy away from open microphones.

120° x 120° dispersion, usable output from 29 Hz to 180 Hz.

Dual-ported 18 inch woofers fire in opposite directions and are driven in reverse polarity.

Requires NX241 Digital TDController and two amplifier channels: each woofer is processed individually.

Internally braced Baltic Birch cabinet minimizes in-band resonances.

Available in structured black coating or dark grey carpet covering.

Integrated flying system for use with curved vertical tangent arrays of GEO T Series modules.

Cabinets designed for stable ground stacking.

GEO T SERIES APPLICATIONS

Mobile or installed sound reinforcement for arenas, clubs, A/V, theater and themed attractions.

High output music applications for large public spaces: transport hubs, outdoor venues, theme parks, etc.

GEO Tangent Array Modules can be used in horizontal or vertical arrays, with or without the CD18 Controlled Directivity Subbass



750mm
29.53"

GEO T Series Tangent Array Modules

T4805
Vertical

T2820
Horizontal/Vertical

▶ CD18
Hypercardioid Subbass



NX241 Digital TDController

The CD18 uses an innovative approach to the control of long wavelength low frequency acoustic energy. Sophisticated signal processing algorithms, individually applied to each of the dual-ported 18 inch woofers, produce substantial forward gain and more than 12 dB attenuation at the rear. The CD18 puts subbass energy where it is needed and keeps it away from open microphones and reverberant surfaces.

The GEO T & S Series are the result of a three year intensive R&D project that has produced three fundamental patent applications in loudspeaker technology. The performance advantages produced by GEO innovations are easily measurable and clearly audible. With two full range tangent array modules and a hypercardioid subbass, the T Series offers total flexibility to design and deploy horizontal or vertical tangent arrays with coherent output. From high-definition musical reproduction to high output paging systems, GEO Technology delivers optimal performance in venues of all shapes and sizes.

NEXO
I N N O V A T E

CD18 CONTROLLED DIRECTIVITY SUBBASS

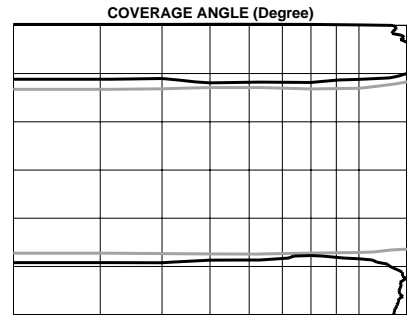
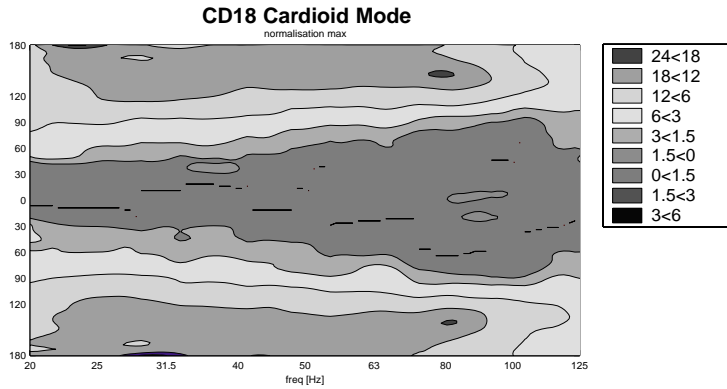

Horizontal (dark) and vertical (light) coverage angles between -6 dB points: cardioid mode.

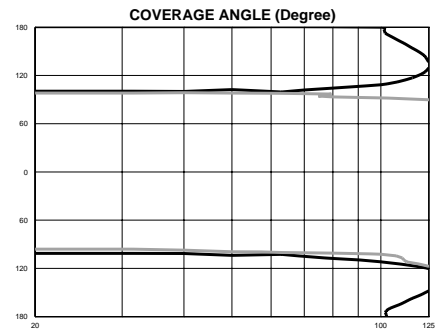
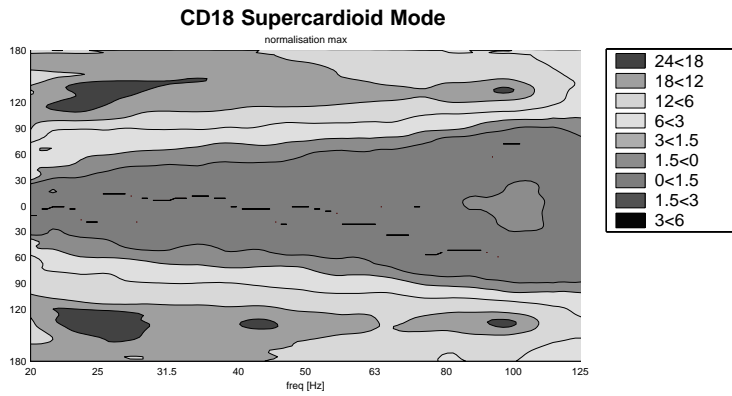

Horizontal (dark) and vertical (light) coverage angles between -6 dB points: supercardioid mode.

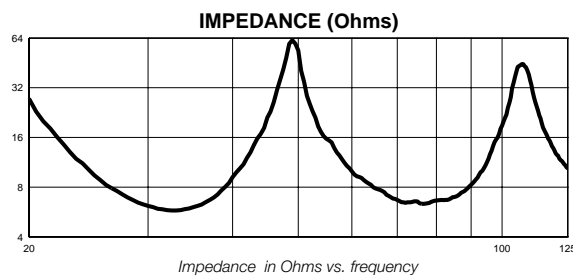
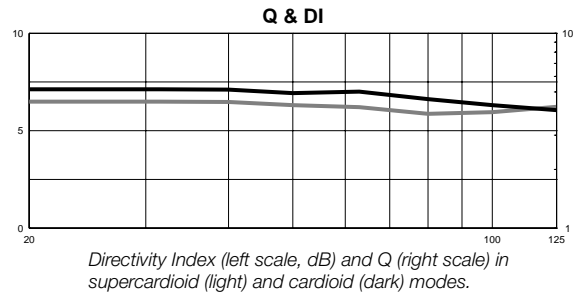
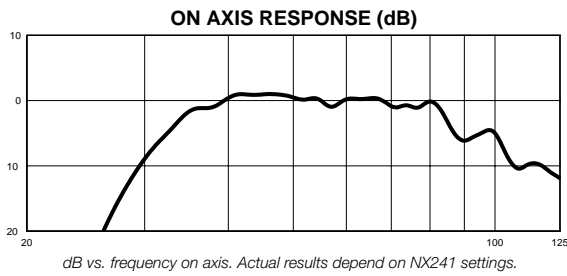

All measurements made with dedicated NX program. Measurements conditions: far field, half space below 400Hz; anechoic above 400Hz. Directivity Index and factor: computer synthesized from coverage. Coverage: 1/3 octave band synthesized from FFT measurements.

flexible

coherent

efficient

scalable

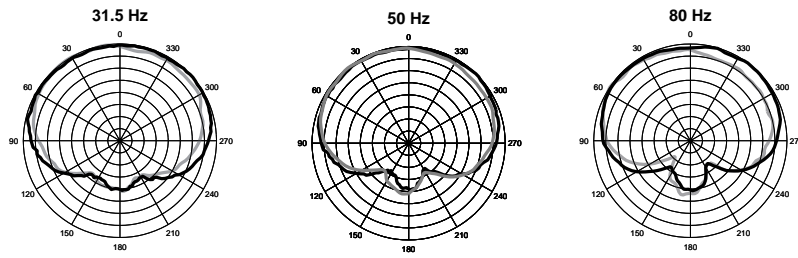

Horizontal (dark) and vertical (light) polar plots: cardioid mode. 3 dB/division.

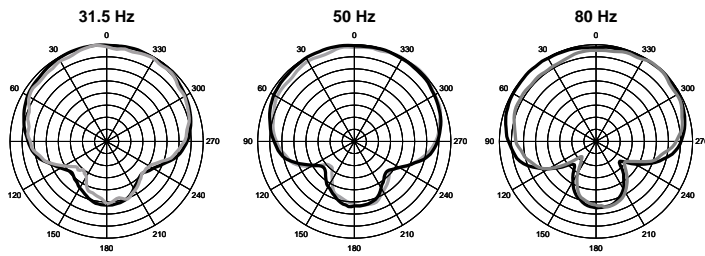

Horizontal (dark) and vertical (light) polars: supercardioid mode. 3 dB/division.

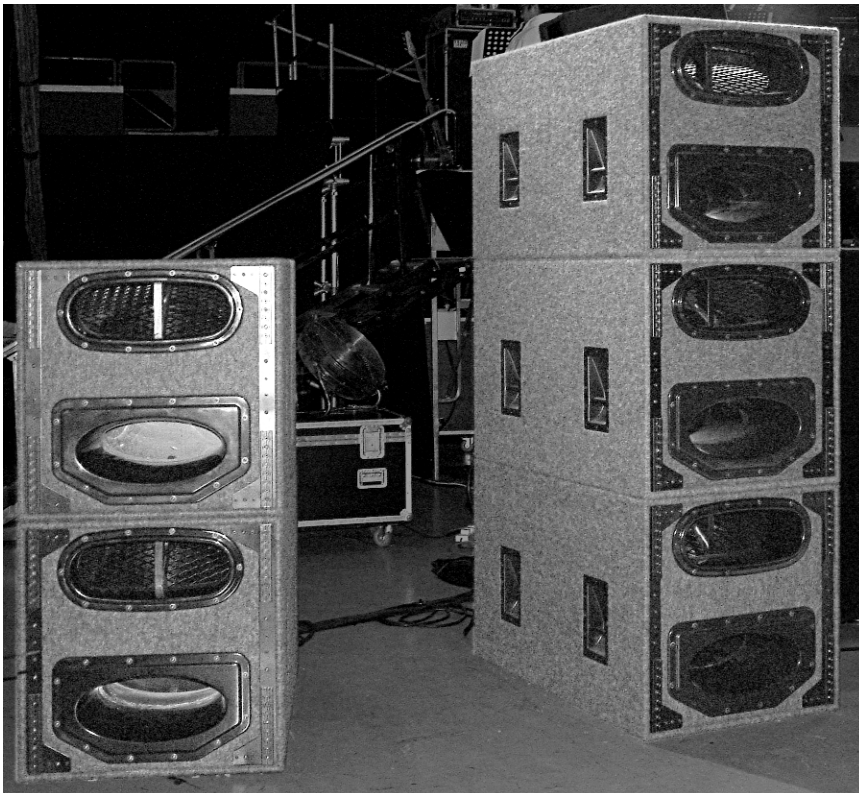

NEXO
I N N O V A T E

flexible

coherent

efficient

scalable



CD18 CONTROLLED DIRECTIVITY SUBBASS

PRODUCT FEATURES

Components	2 x 18" (46cm) long excursion neodymium 8 Ohm drivers
Height x Width x Depth	750 x 1200 x 750 mm (29 1/2" x 47 1/4" x 29 1/2")
Shape	Rectangular
Weight: Net	116 kg (256 lbs)
Connectors	2 x NL4MP SPEAKON 4 pole (In & Through)
Construction	Baltic birch ply finish with structured black coating. Dark grey carpet finish also available.
Flying points	Integral flying system.

SYSTEM SPECIFICATIONS CD18 with NX241 TDController

Frequency Response @-3dB [a]	32 Hz – 80 Hz
Usable Range @-6dB [a]	29 Hz – 180 Hz
Sensitivity 1W @ 1m [b]	105 dB SPL Nominal
Peak SPL @ 1m [b]	145 dB Peak
Dispersion [c]	Cardioid or supercardioid pattern over the entire useable bandwidth depending on the NX241 Digital TDController set up.(two channels of the NX241 are used for the process).
Directivity Index [c] and supercardioid mode.	Q=4.3 DI=6.3 dB and Q=5.3 DI=7.2 dB over the entire useable bandwidth for respectively cardioid
Crossover Frequency	80 Hz active through NX241 Digital TDController.
Nominal Impedance	2 x 8 Ohms
Recommended Amplifiers	2 amplifier channels are required for cardioid operation, each rated at 1500 to 3000 Watts into 4 ohms per channel. Up to 2 complete CD18s per channel may be connected to a two channels amplifier.

SYSTEM OPERATION

Electronic Controller	The NX241 Digital TDController presets are precisely matched to the CD18 and include sophisticated protection systems. Using CD18 sub-bass without a properly connected NX241 Digital TDController will result in poor sound quality and can damage components.
Speaker Cables	The front loudspeaker of the CD18 is wired 2+ & 2- while the rear loudspeaker is wired 1- & 1+. The CD18 must use separate cables to the main system.
Rigging System [d]	Please refer to the user manual before any operation.

SHIPPING & ORDERING

Packaging	CD18s are packaged individually. Order as CD18-C (finished in grey carpeting) or CD18-P (finished in black structured coating).
Shipping Weight & Volume	1x CD18 = 131.5 kg (263 lbs), .98 cu m (34.4 cu ft)

As part of a policy of continual improvement, NEXO reserves the right to change specifications without notice.

[a] Response curves and data: anechoic far field above 400 Hz, half-space anechoic below 400 Hz. Usable range data: frequency response capability with TD crossover slopes removed. [b] Sensitivity & peak SPL: will depend on spectral distribution. Measured with band limited pink noise. Refers to the specified +/- 3 dB range. Data are for speaker + processor + recommended amplifier combinations. [c] Directivity curves and data: 1/3 octave smoothed frequency response, normalized to on-axis response. Data obtained by computer processing of off-axis response curves. [d] Please refer to the user manual.

approved product

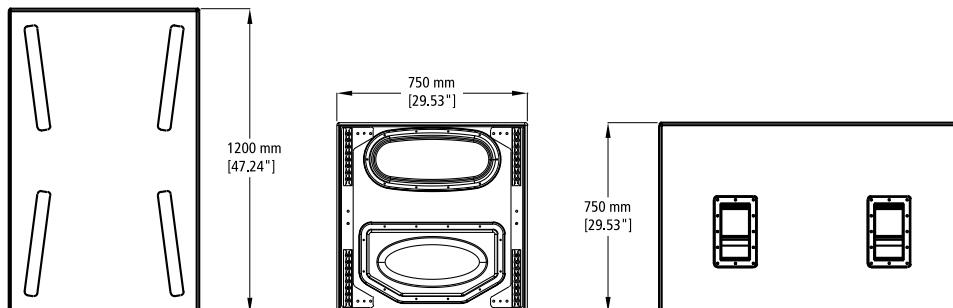

LIMITED WARRANTY

Nexo loudspeakers and electronics are covered against defects in workmanship or materials for a period of two (2) years from the original date of purchase. At the option of Nexo, the defective item will be repaired/replaced with no charge for materials/labor. The item is to be adequately packaged and dispatched, pre-paid, to a Nexo authorized distributor/service center. Unauthorized repair shall void the warranty. This Nexo warranty does not cover cosmetics or finish and does not apply to any items which in Nexo's opinion have failed due to user abuse, accidents, modifications or any type of misuse.

www.nexo-sa.com

NEXO is a world leader in the design and manufacture of loudspeaker systems for sound reinforcement. Since 1979 we have pursued practical solutions by addressing problems at fundamental levels. Each new design is generated using proprietary computer simulation software. Extensive modeling and simulation of critical parameters enables us to translate conceptual breakthroughs into significant cost and performance gains.

Nexo's comprehensive line includes the breakthrough GEO Series, based on fundamental wavesource patents, the compact, versatile PS Series, the world standard Alpha System and the Alpha[®] Series. Loudspeakers, analogue and digital control electronics and amplification are all designed to deliver

Sonic Innovation That Works.

NEXO S.A.
154 allée des Erables
ZAC de PARIS NORD II B.P. 50107
F-95950 Roissy CDG CEDEX
France

Tél: +33 1 48 63 19 14
Fax: +33 1 48 63 24 61
E-mail: info@nexo.fr

Nexo USA, Inc.
2165 Francisco Blvd.
Suite E2
San Rafael, CA 94901

Phone: +1 415 482 6600
Fax: +1 415 482 6110
E-mail: info@nexo.cc

NEXO Far East Pte Ltd
No. 10 Ubi Crescent
#02-35/36 Ubi Techpark (Lobby C)
Singapore 408564

Tel: +65 742 5660
Fax: +65 742 8050
E-mail: info@nexo-sg.com

NEXO

INNOVATE